



Deubl Alpha door frames

DORMA

**New and super narrow –
the perfect aluminium door
frame for glass assemblies:**

- Deubl AT 23
single acting door frame
- Deubl AT 23 E
single acting door frame
- Deubl AT 44
single acting door frame
- Deubl AT 44 EA
single acting door frame
- Deubl PT 35
double acting door frame
- Deubl MRX 30
door frame surround

All frame types have been
tuned to fit DORMA-Glas
fittings.

Standard fittings for a rebate
depth of 24 mm are used on
the single acting door frames
AT 44 and AT 44 EA.

Standard finishes

- Satin silver anodised
- Painted white RAL 9016
- Similar satin stainless
steel anodised

Special finishes

- Painted (RAL), anodised

Note regarding customising

All Deubl frames are produ-
ced to your given measure-
ments. 2, 3 or 4 measure-
ments are needed depending
on system type (see techni-
cal information and order
sheet). With this, it is
possible to plan all door
frame types.

Door frames are prepared for
on site assembly.



Please note:
Fittings have to be ordered
separately.

Deubl AT 23 single acting door frame

for 8 mm glass

With concealed fixing and suitable for DORMA special hinges Art. no. 11.294, 12.050, 25.450 and locks Junior Office, Junior Office Classic und ARCOS Office.

Max. door weight

- with 2 hinges = 40 kg
- with 3 hinges = 55 kg

Standard finishes

- Satin silver anodised
- Painted white RAL 9016
- Similar satin stainless steel anodised

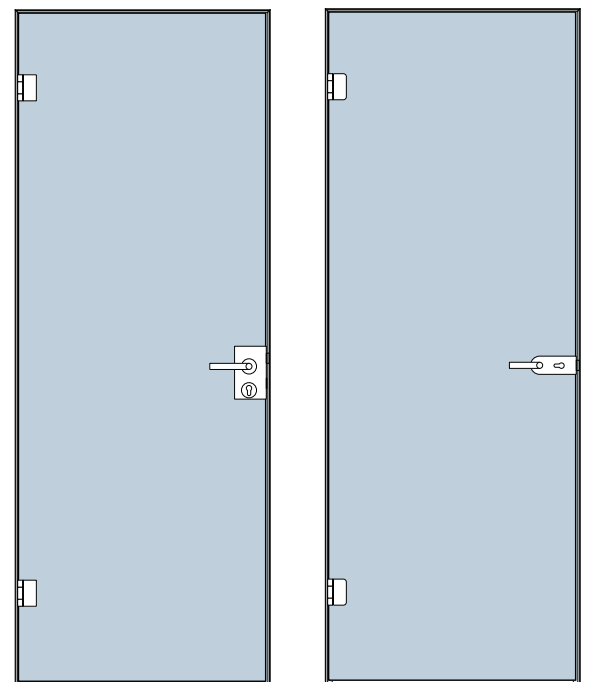
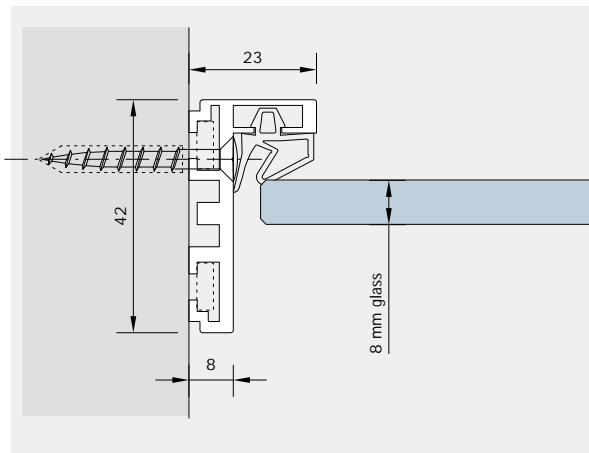

Deubl AT 23
Single acting door frame

Deubl AT 23 E corner single acting door frame

for 8 mm glass

With concealed fixing and suitable for DORMA special hinges Art. no. 11.294, 12.050, 25.450 and locks Junior Office, Junior Office Classic und ARCOS Office.

Max. door weight

- with 2 hinges = 40 kg
- with 3 hinges = 55 kg

Standard finishes

- Satin silver anodised
- Painted white RAL 9016
- Similar satin stainless steel anodised

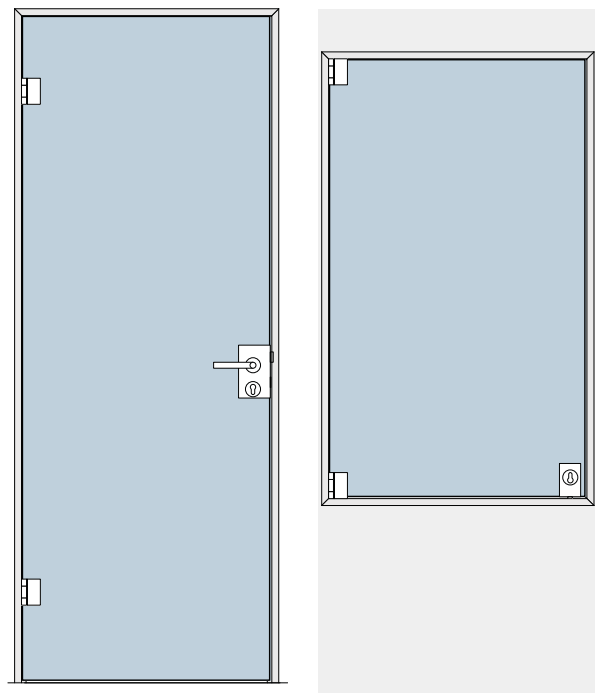
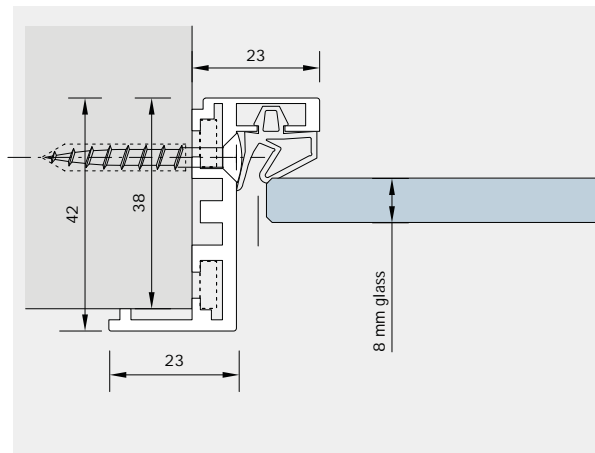

Deubl AT 23 E
Corner single acting door frame

The profiles

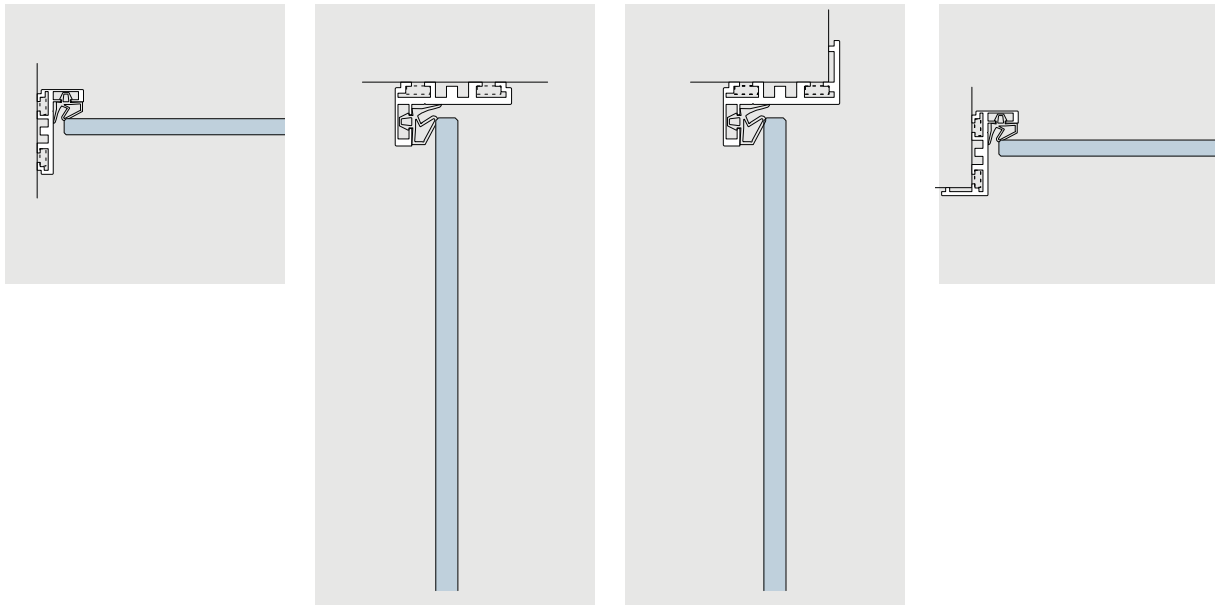

Single acting door frame AT 23

Corner single acting door frame AT 23 E

Fitting type examples

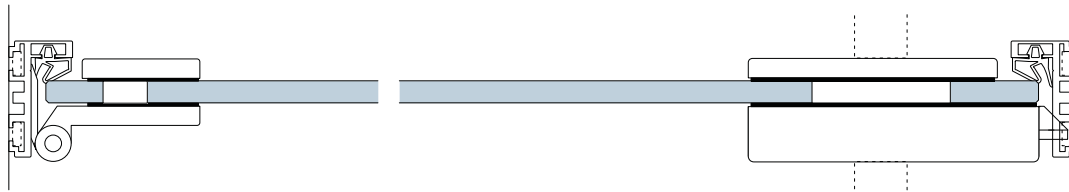

Deubl AT 23 with DORMA special hinge Art. no. 11.294 resp. 12.050, lock Junior Office / Junior Office Classic

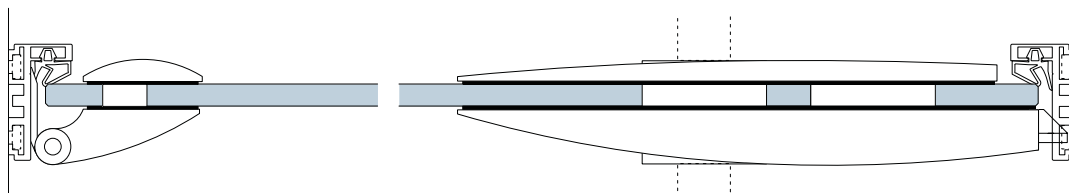

Deubl AT 23 with DORMA special hinge ARCOS Art. no. 25.450,, lock ARCOS Studio

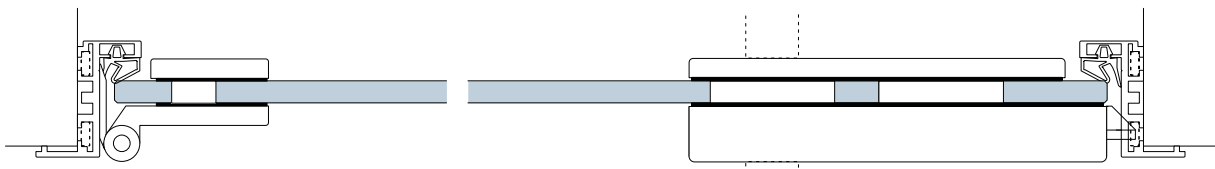

Deubl AT 23 E with DORMA special hinge Art. no. 11.294 resp. 12.050, lock Studio Rondo / Classic

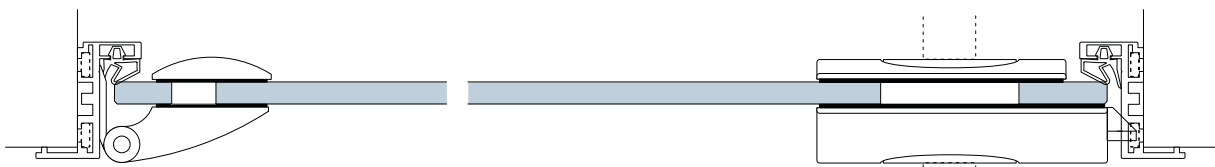

Deubl AT 23 E with DORMA special hinge ARCOS Art. no. 25.450, lock ARCOS Office

Deubl AT 23 single acting door frame

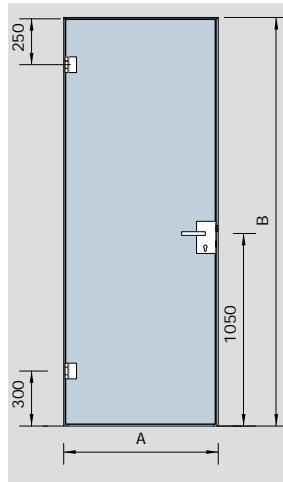
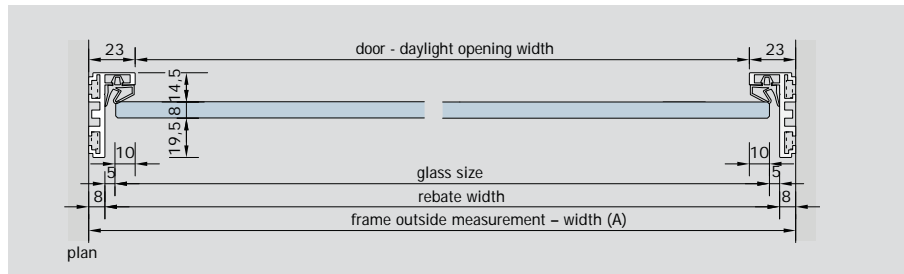

Example for measurements and set standard measurements for hinges and door levers.

Deubl AT 23 E corner single acting door frame

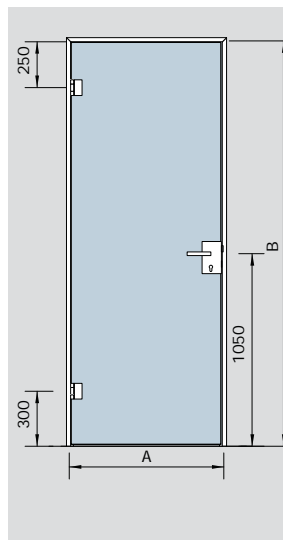
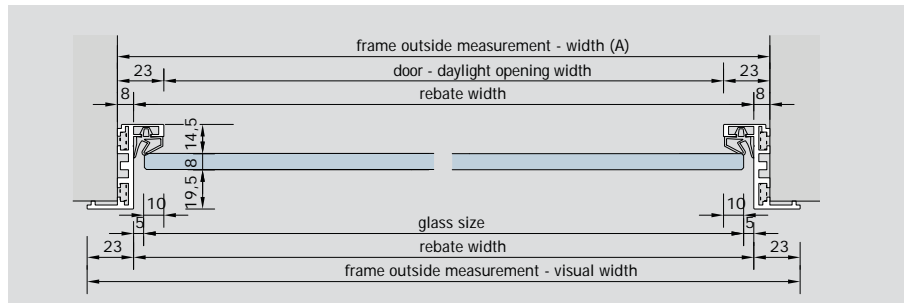
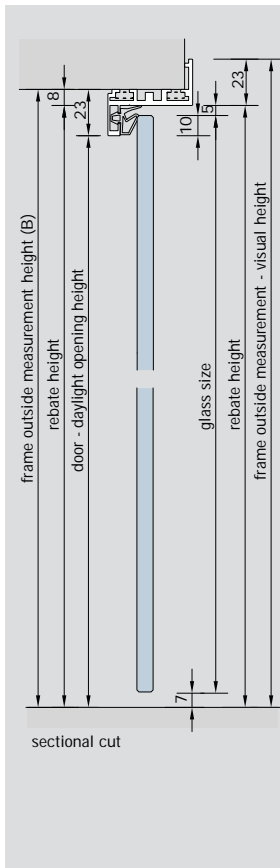

Example for measurements and set standard measurements for hinges and door levers.

Deubl AT 23 single acting door frame

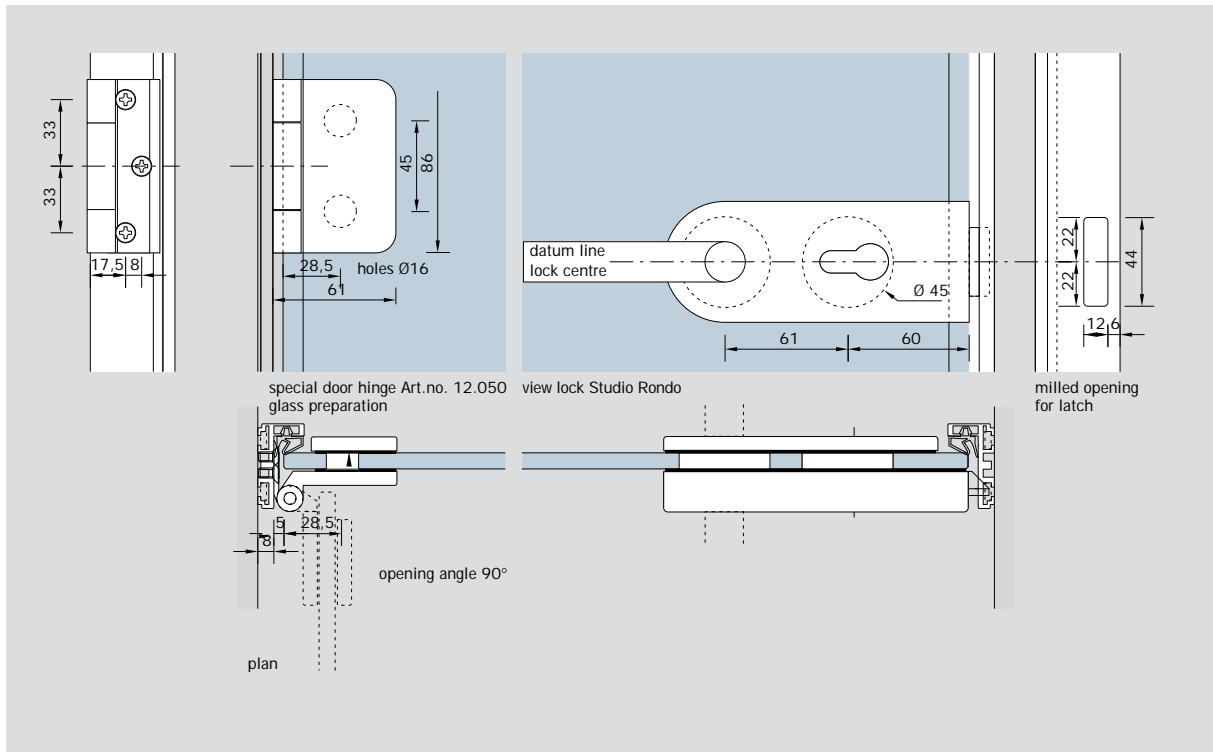

Deubl AT 23 E corner single acting door frame

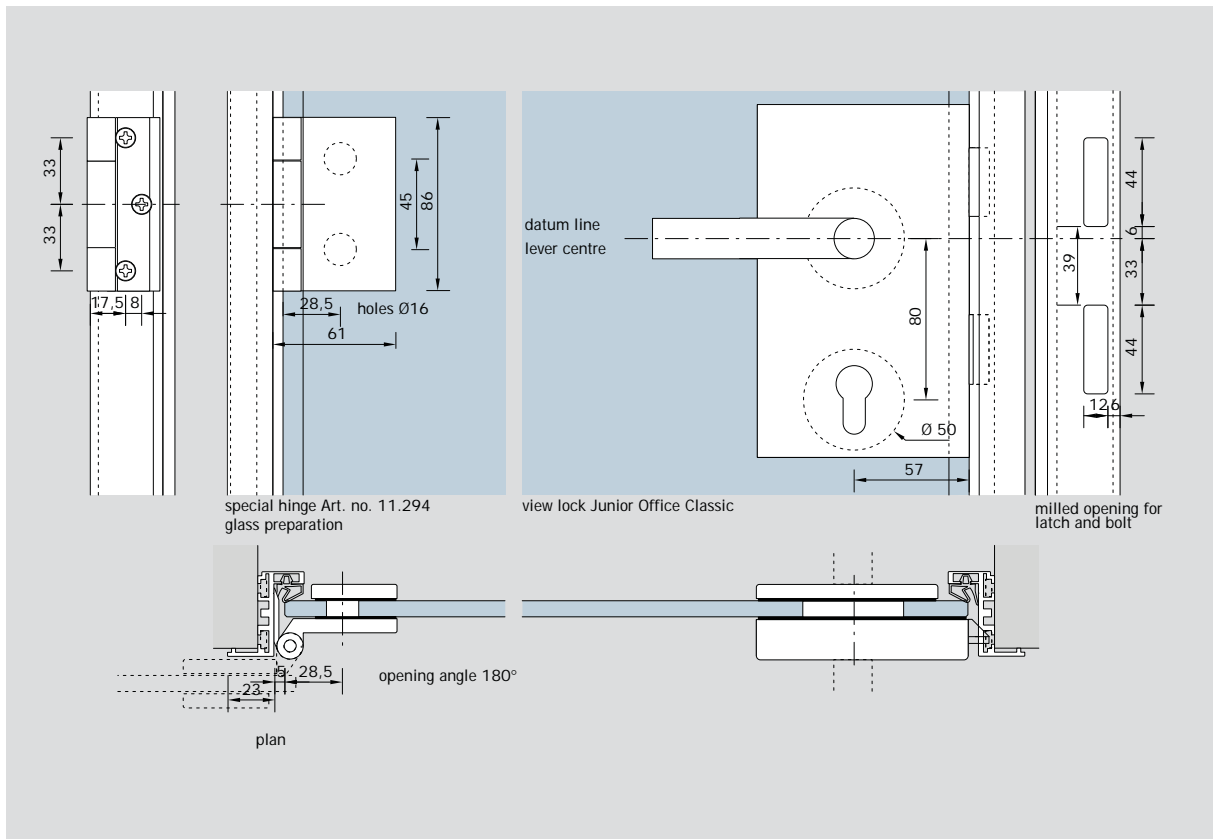

Deubl AT 23 single acting door frame

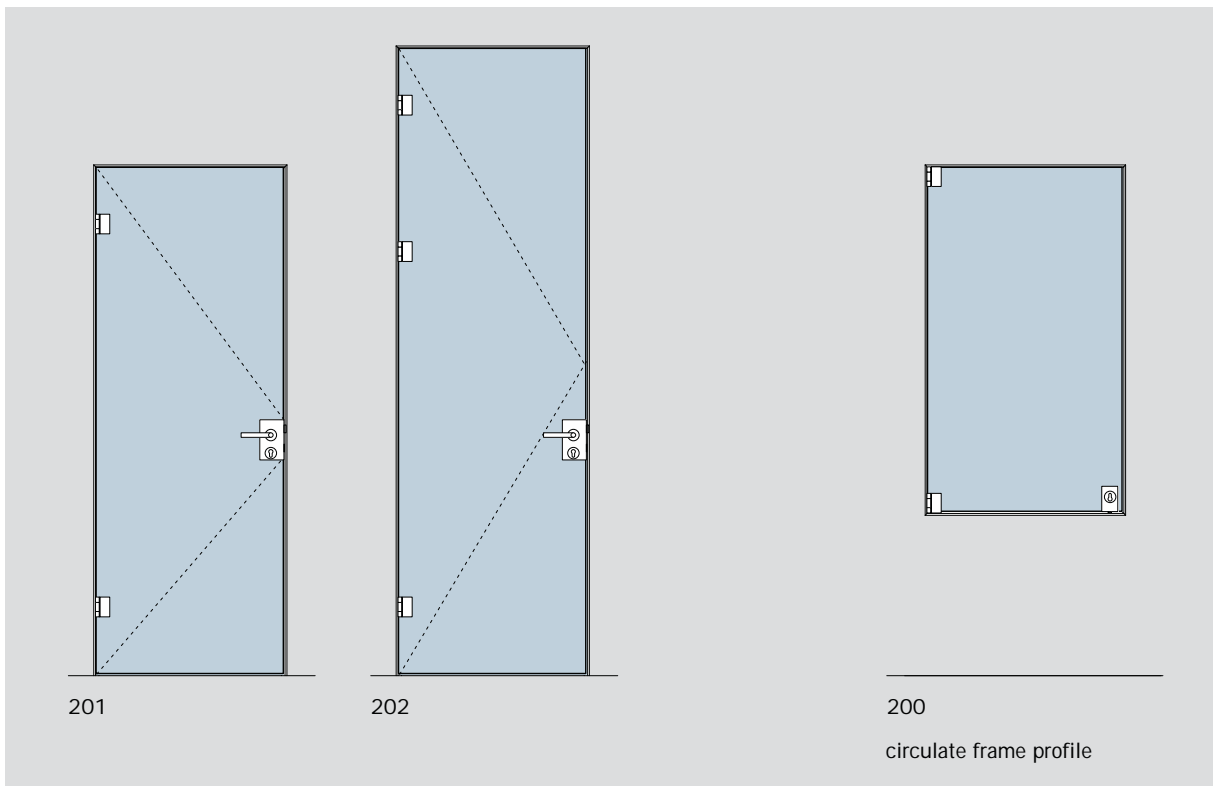

Deubl AT 23 E corner single acting door frame

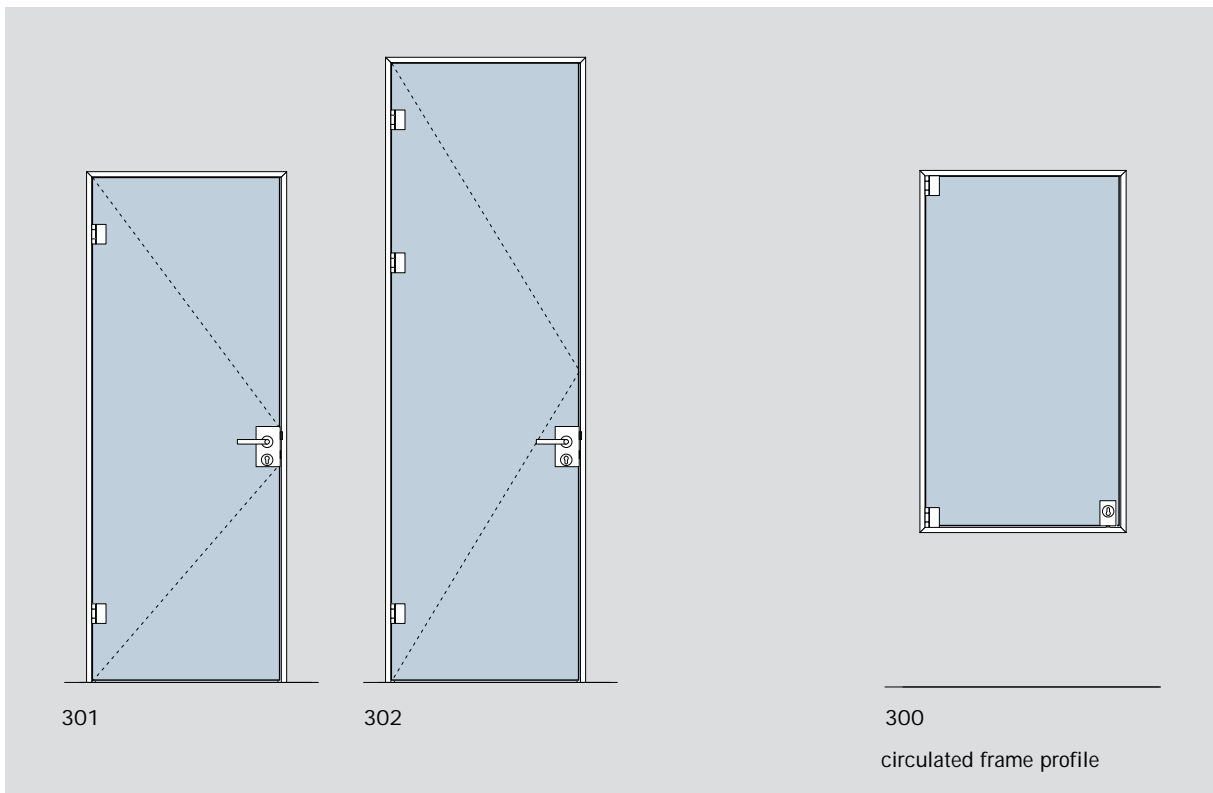

Deubl AT 44 single acting door frame

for 8 and 10 mm glass

For single and double leaf door assemblies, with overpanel and/or fixed sidelite.

Suitable for DORMA Junior (Office, Office Classic), Studio (Classic, Rondo) and ARCOS (Office, Studio).

Max. door weight
45 to 65 kg
(see also pages 12 and 13)

Standard finishes
– Satin silver anodised
– Painted white RAL 9016
– Similar satin stainless steel anodised

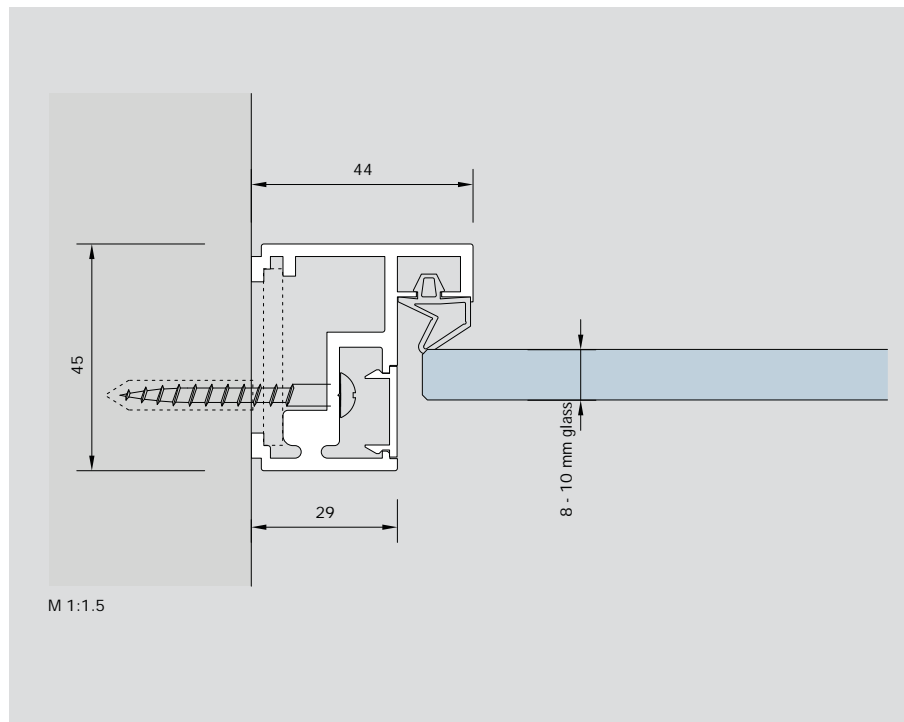

Deubl AT 44
3 sided frame profile

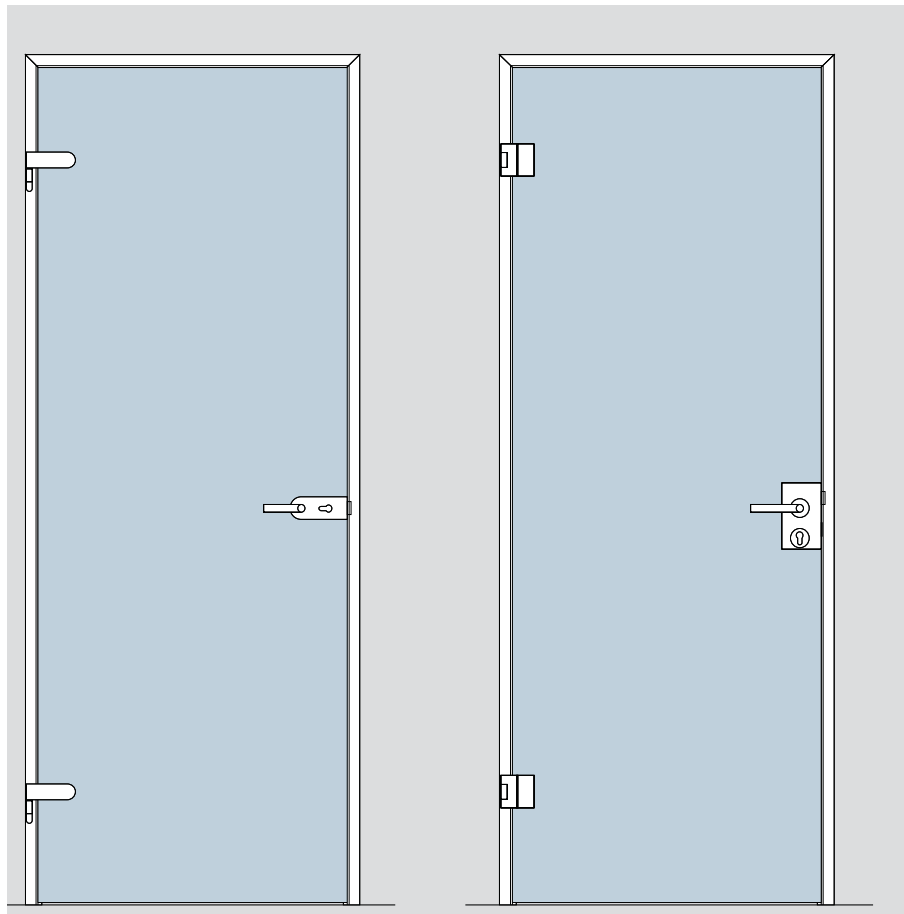

The Profiles

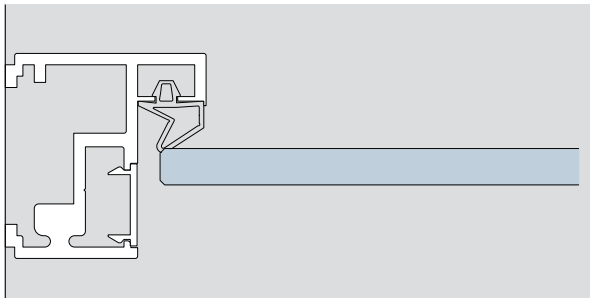

Deubl AT 44 - frame profile

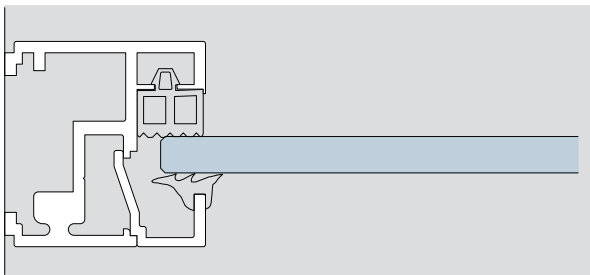

Deubl AT 44 - fixed glass

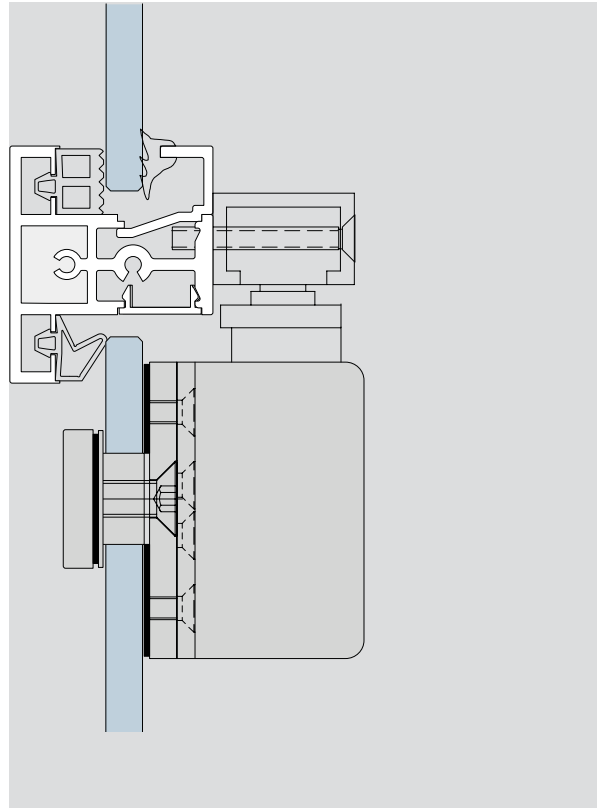

slide channel closer DORMA TS 92 on rung profile

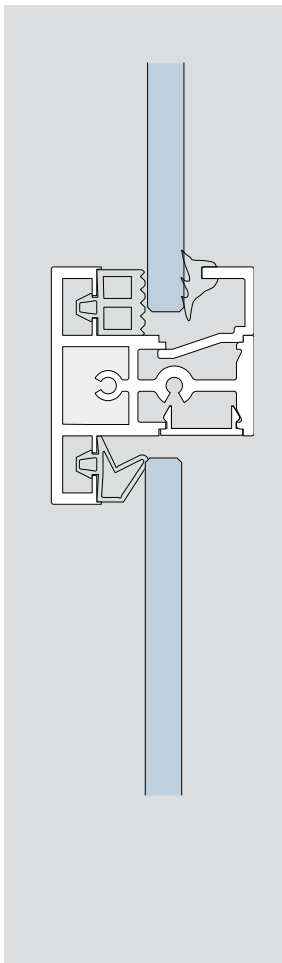

rung profile

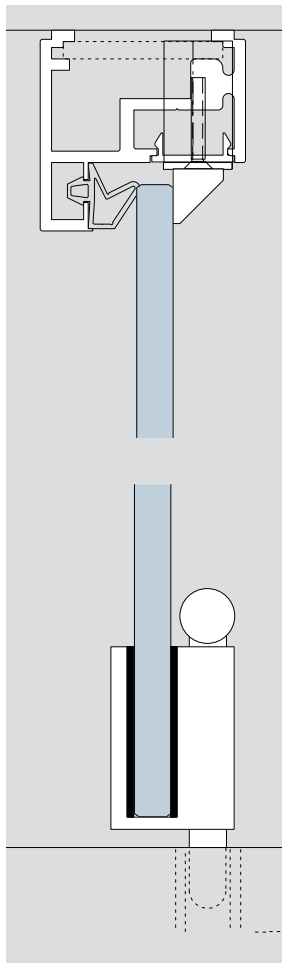

frame profile

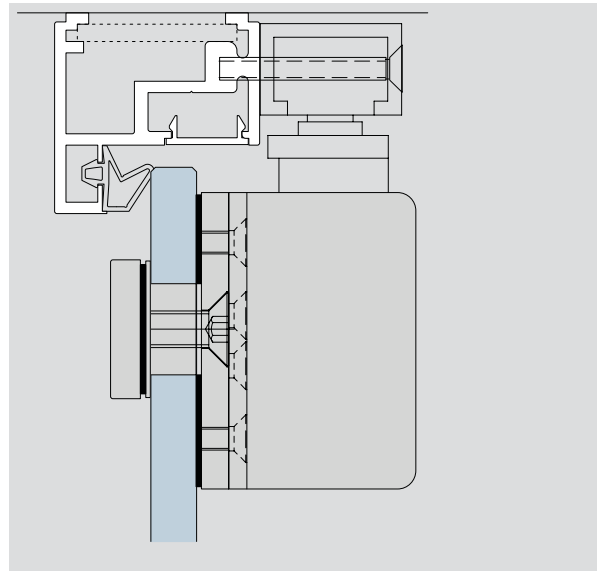

slide channel closer DORMA TS 92 on frame profile

Fitting type examples

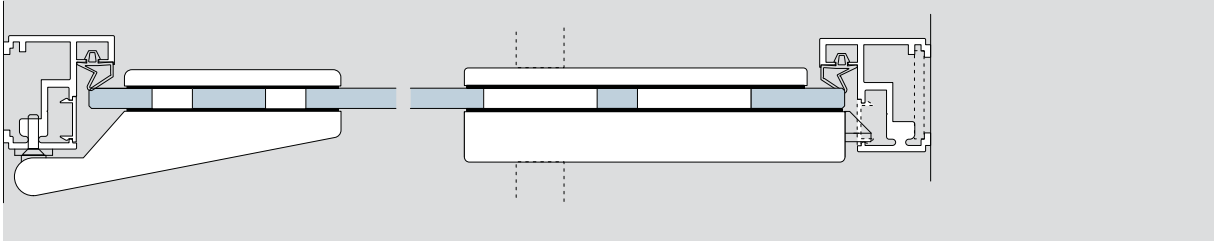

Deubl AT 44 - with DORMA Studio (Classic, Rondo)

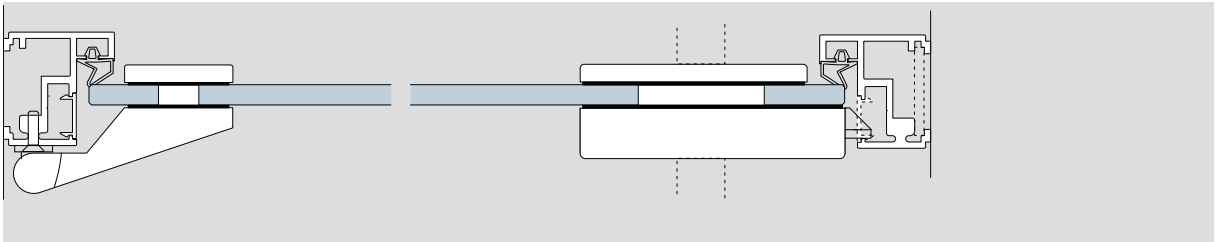

Deubl AT 44 - with DORMA Junior (Office, Office Classic)

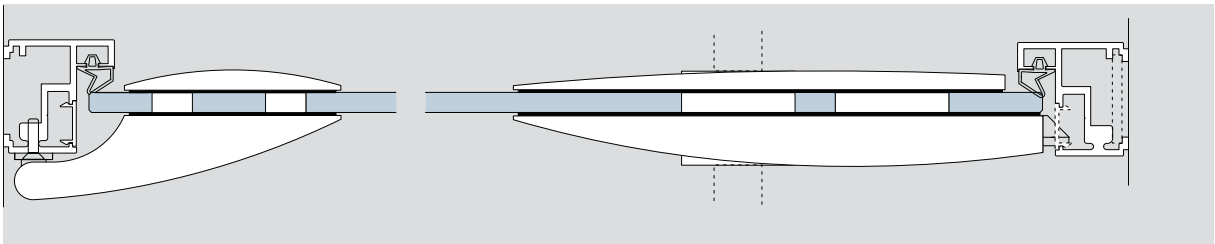

Deubl AT 44 - with DORMA ARCOS Studio

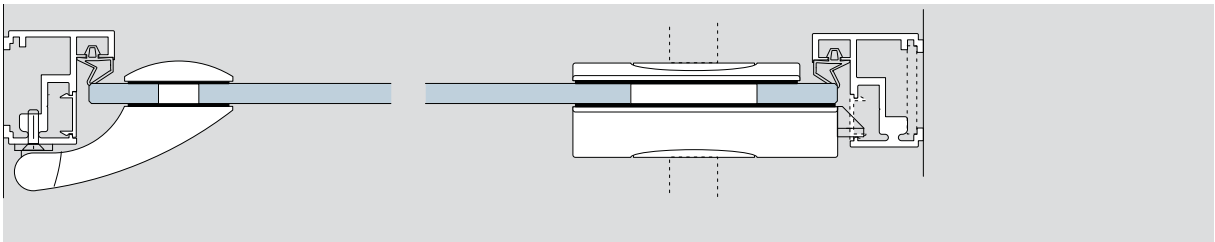

Deubl AT 44 - with ARCOS Office

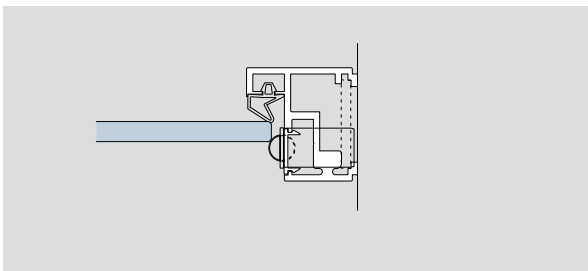

round bolt door catch

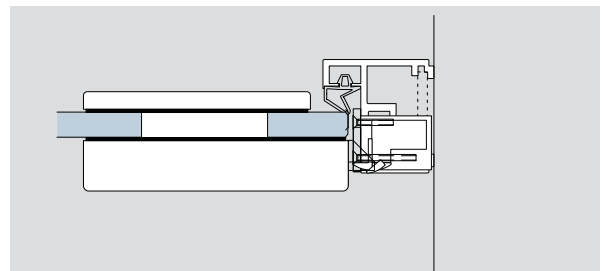

electric strike release for locks Studio und Junior

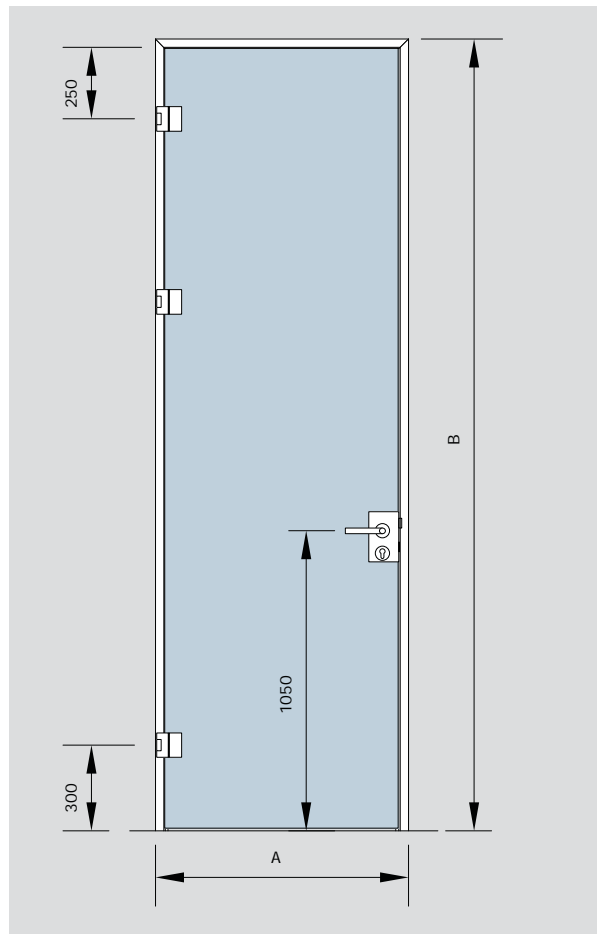
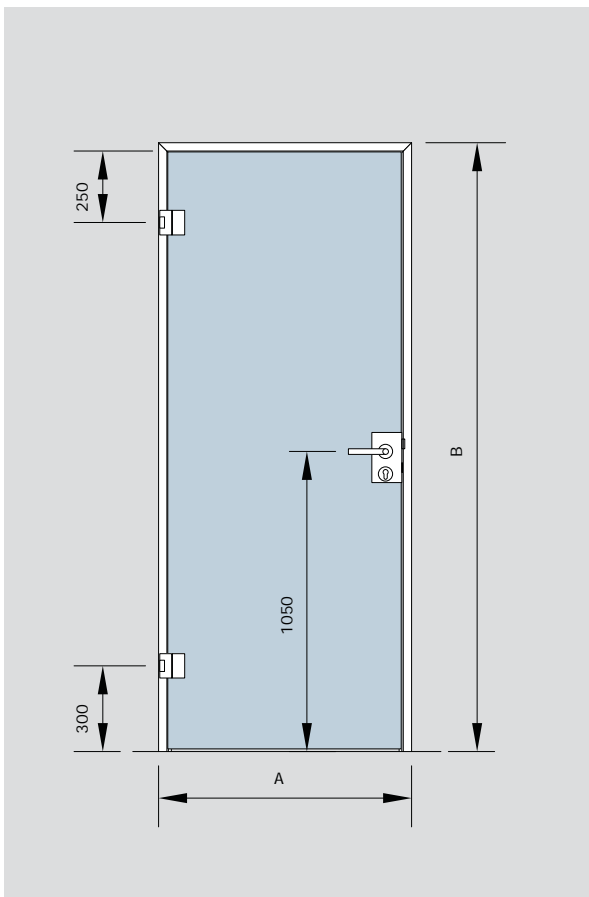
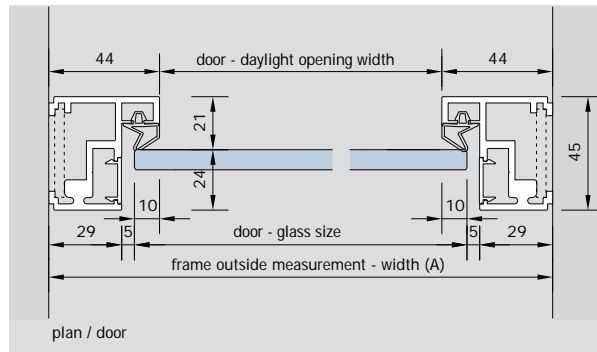
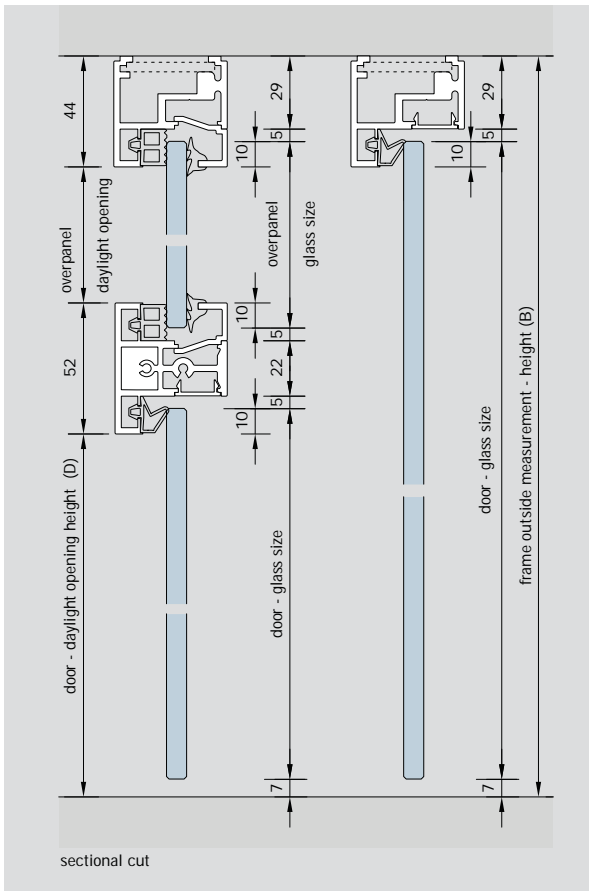

Example for measurements and set standard measurements for hinges and door levers

Max. door weight

Junior types - with 2 hinges = 55 kg

Junior types - with 3 hinges = 65 kg

Studio types - with 2 hinges = 45 kg

Studio types - with 3 hinges = 50 kg

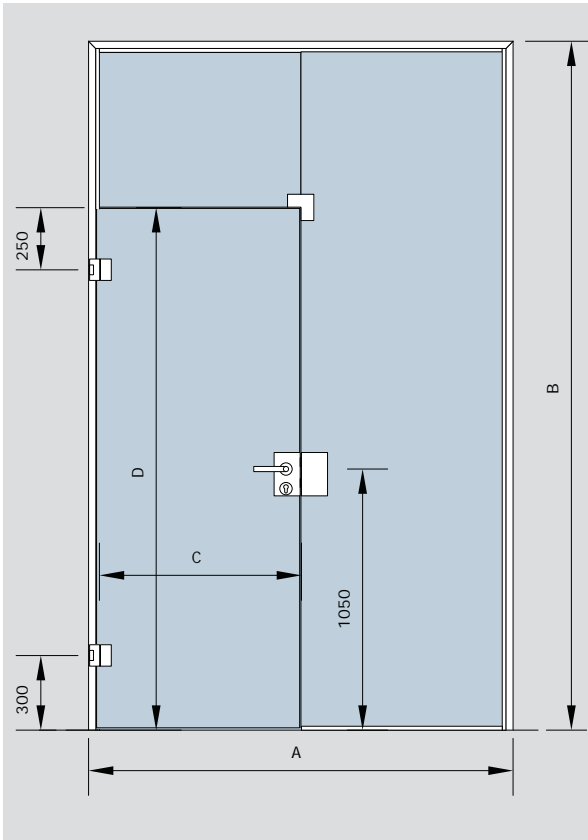
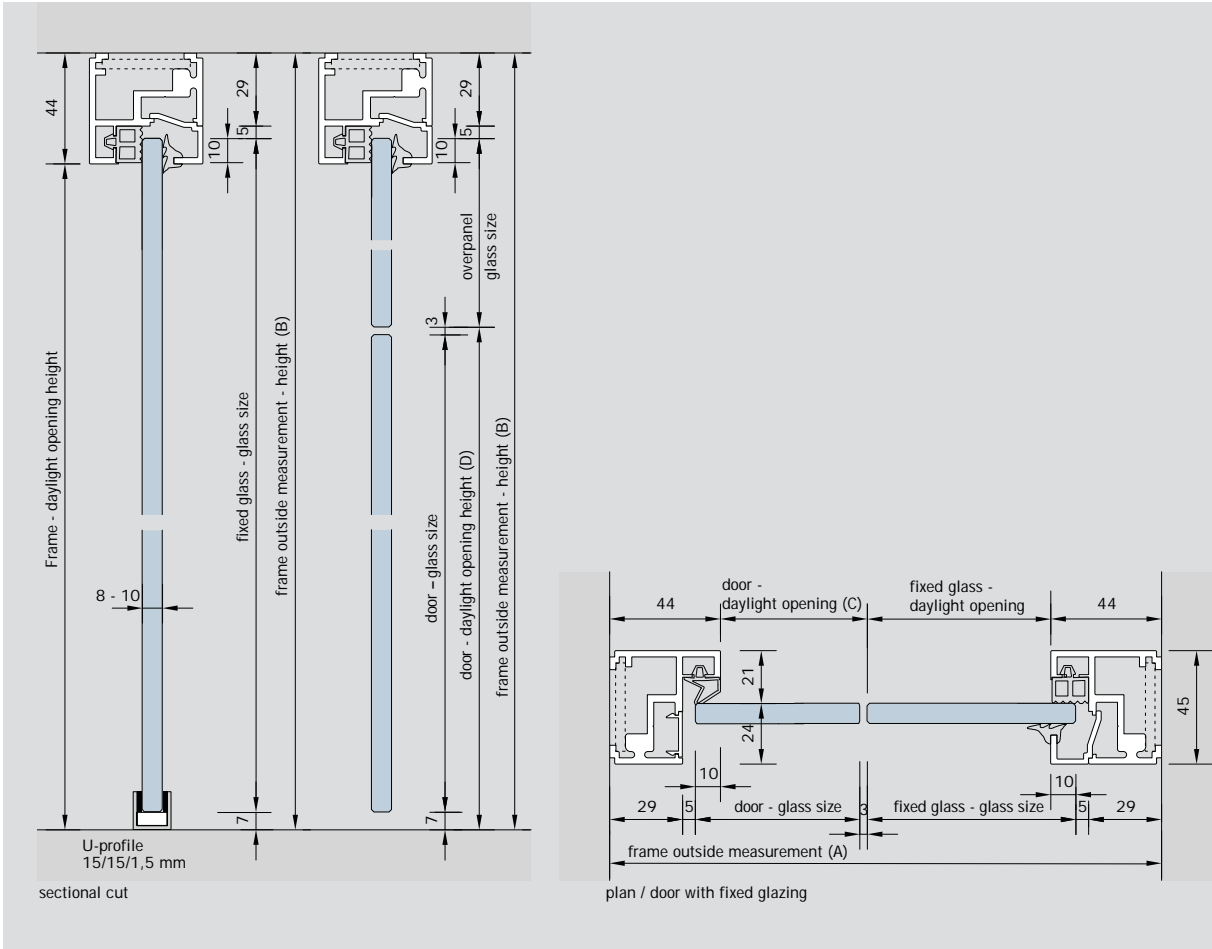

Example for measurements and set standard measurements for hinges and door levers

Max. door weight
 Junior types - with 2 hinges = 55 kg
 Junior types - with 3 hinges = 65 kg

Studio types - with 2 hinges = 45 kg
 Studio types - with 3 hinges = 50 kg

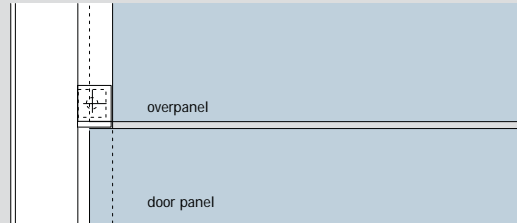

overpanel fixing adjustable angle bracket

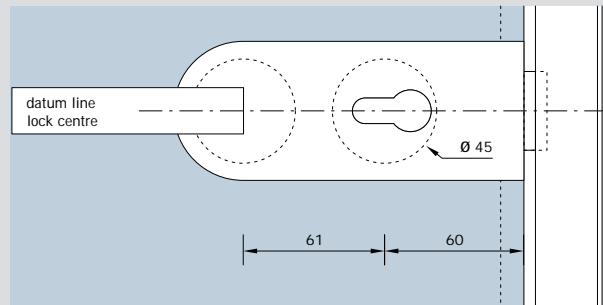
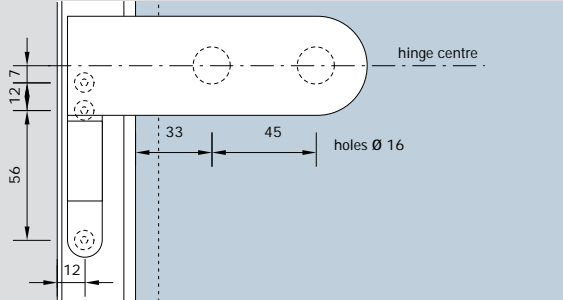

view lock Studio Rondo

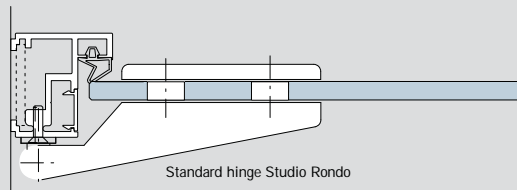

Standard hinge Studio Rondo
Studio Rondo with screw-on frame pivot

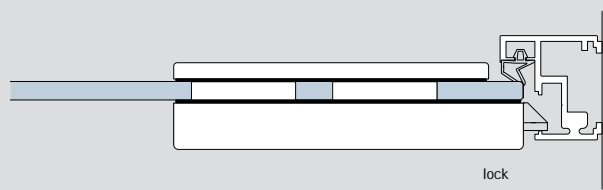

lock

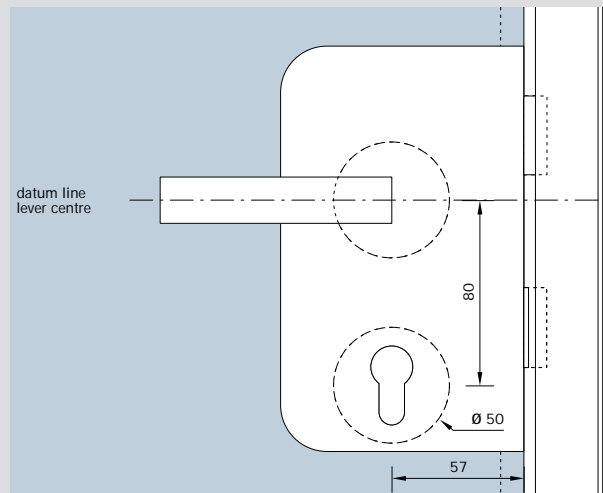
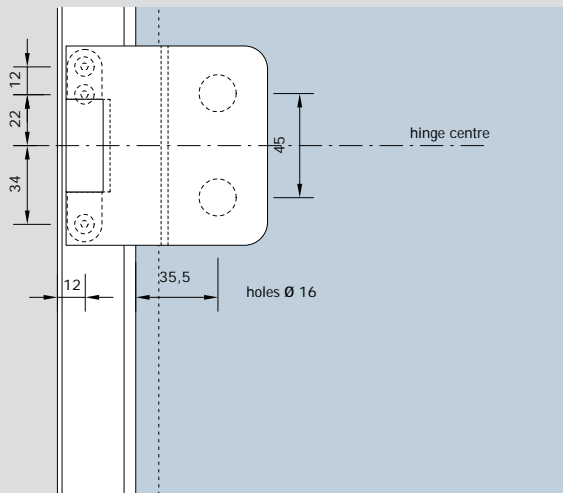

view lock Junior Office

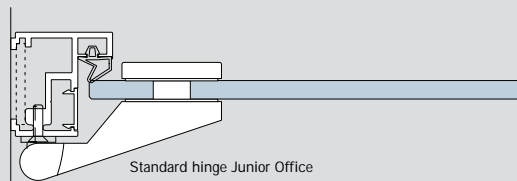

Standard hinge Junior Office
Junior Office with screw-on frame pivot

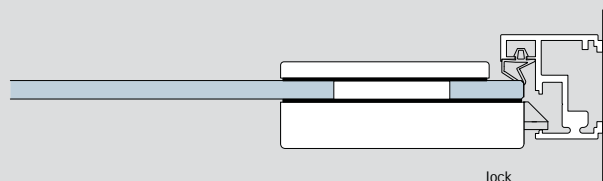

lock

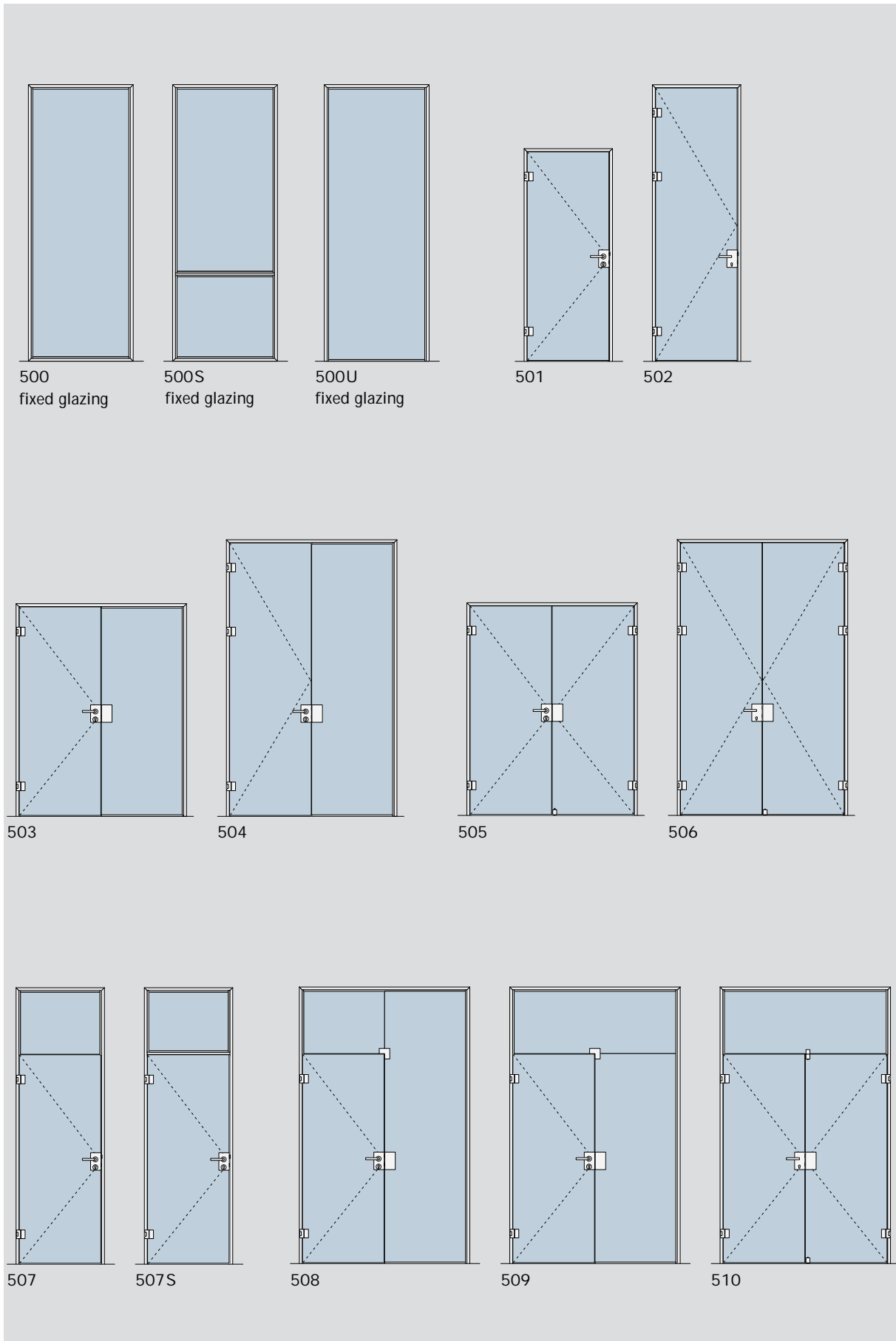

Deubl AT 44 EA single acting door frame

for patch fittings EA,
for 10 mm glass

With concealed fixing and
suitable for single and
double leaf door assemblies,
with overpanel and/or fixed
sidelite.

Suitable for DORMA EA
patch fittings with matching
locks and levers.

Max. door weight
80 kg

Standard finishes
– Satin silver anodised
– Painted white RAL 9016
– Similar satin stainless
steel anodised

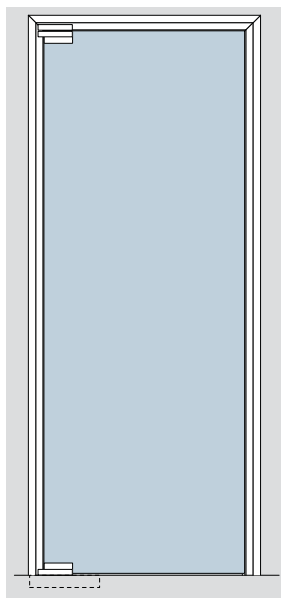
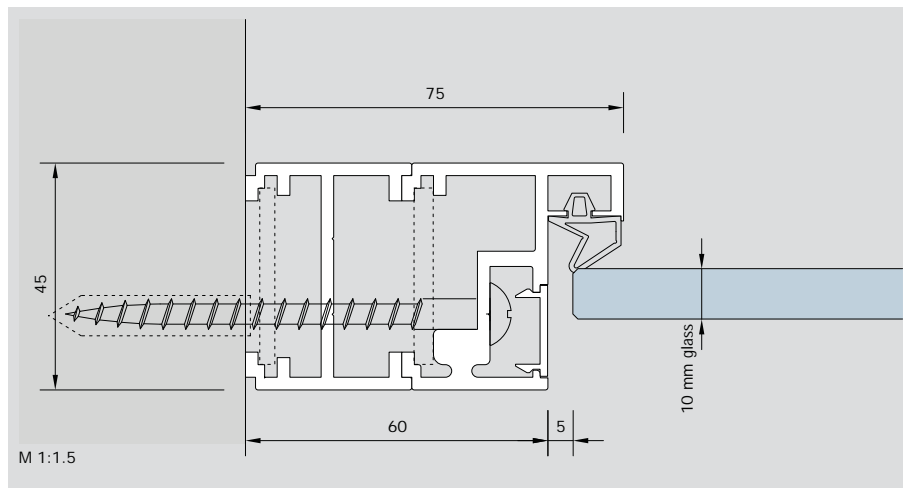

Type A
Deubl AT 44 EA
3 sided frame profile with
3 sided accessory profile for
floor closer (BTS).

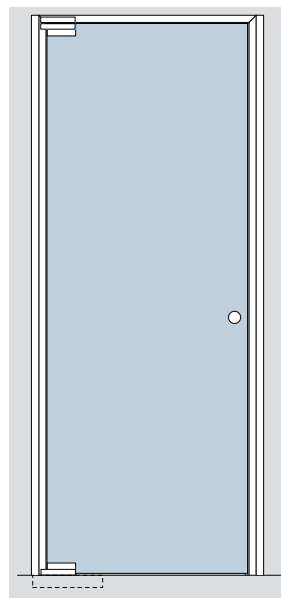

Type B
Deubl AT 44 EA
3 sided frame profile with
2 sided accessory profile for
floor closer (BTS).

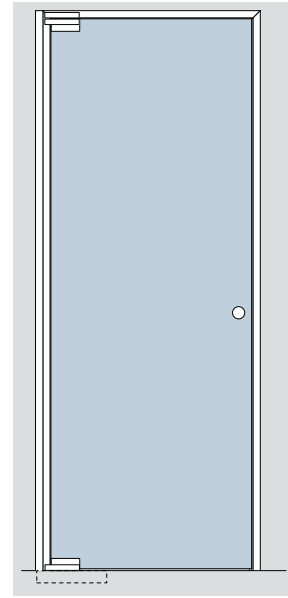

Type C
Deubl AT 44 EA
3 sided frame profile with
1 sided accessory profile for
floor closer (BTS).

The profiles

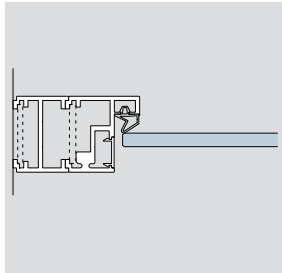

Deubl AT 44 with accessory profile

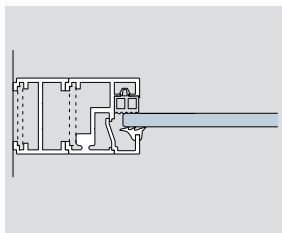

Deubl AT 44 fixed glazing with accessory profile

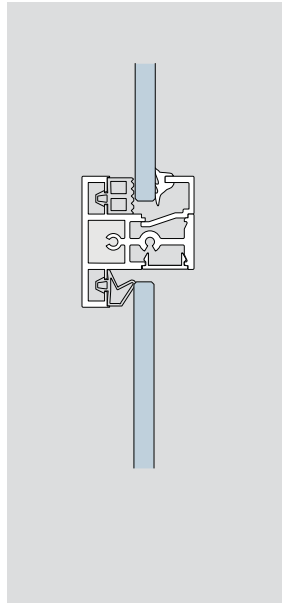

Rung profil

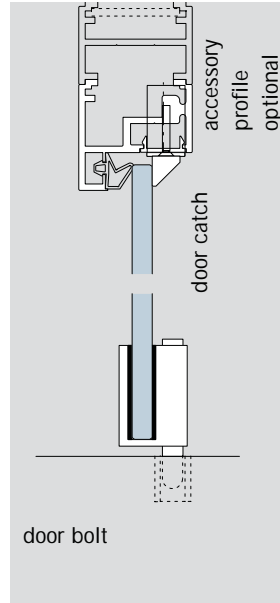

door bolt

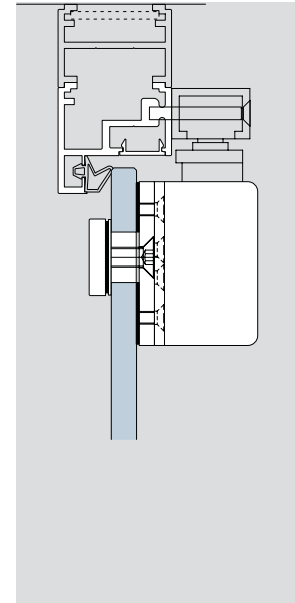

Slide channel door closer DORMA TS 92

Fitting type examples

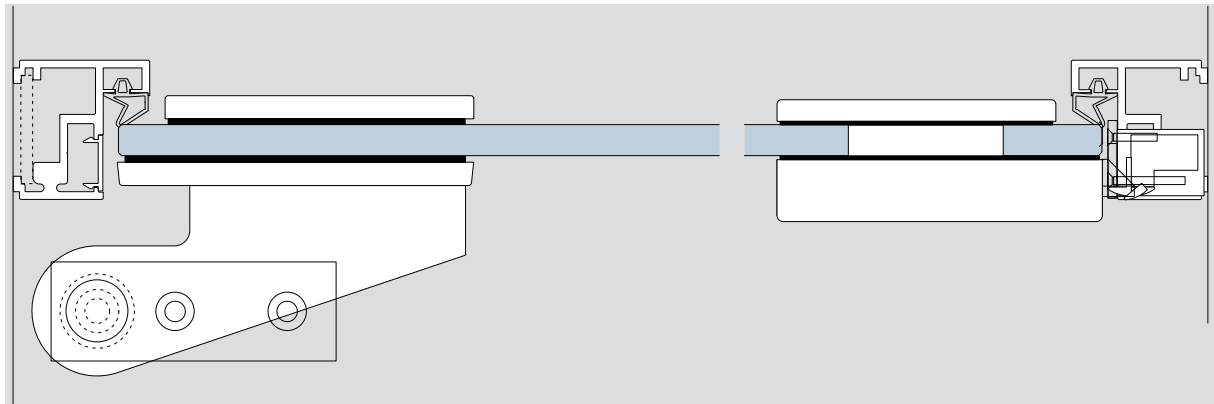

Deubl AT 44 with DORMA EA, and floor pivot bearing Art. no. 01.106

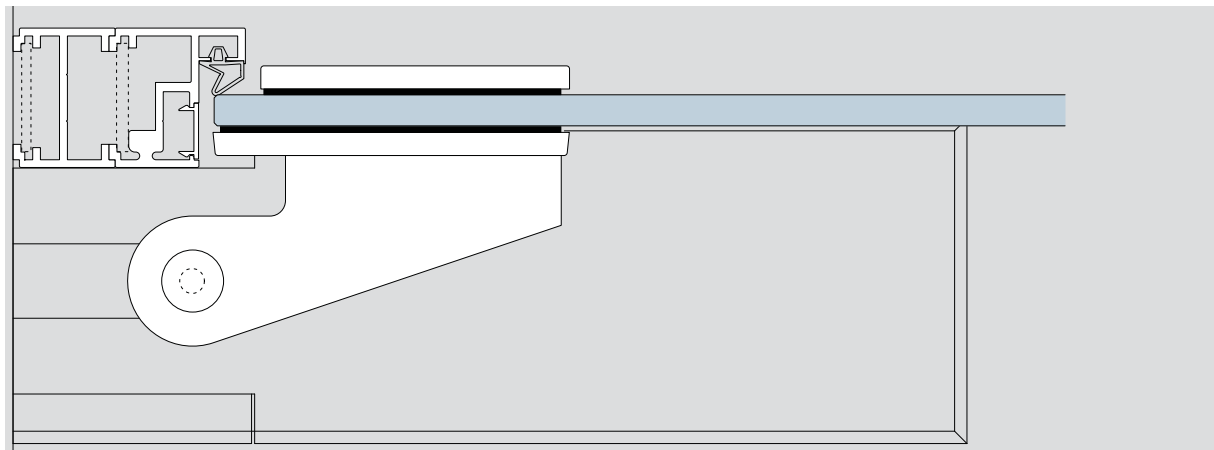

Deubl AT 44 with DORMA EA, and floor closer DORMA BTS 75V

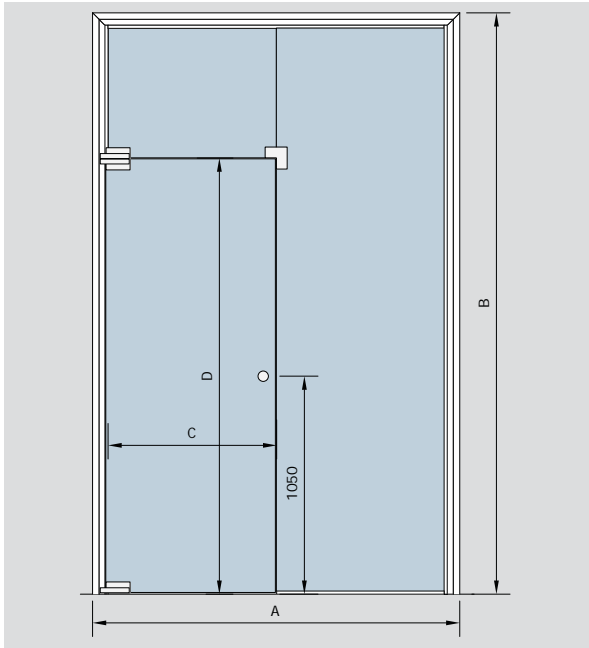

Type A

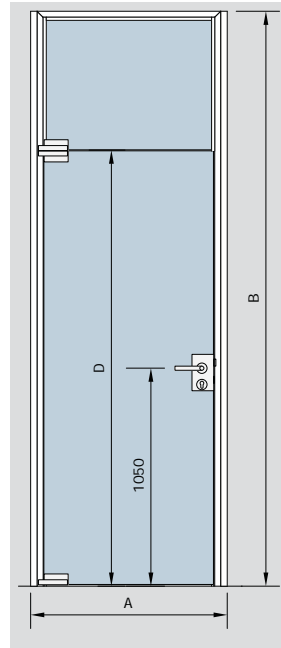

Type B

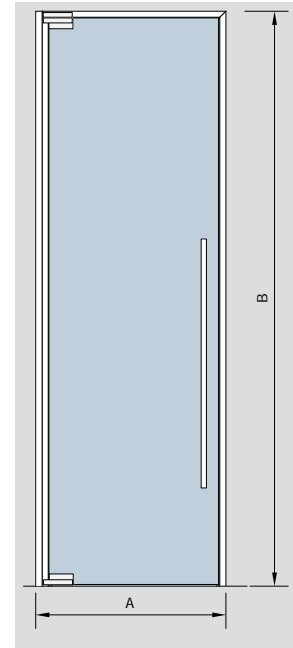

Type C

Example for measurements and set standard measurements for door levers

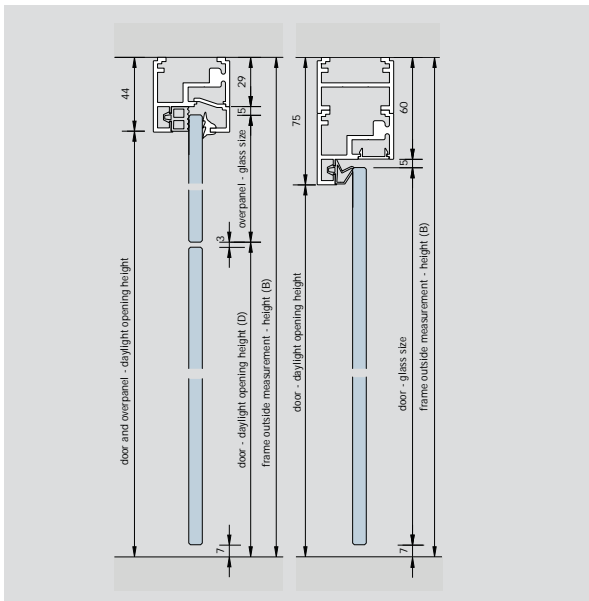

sectional cut

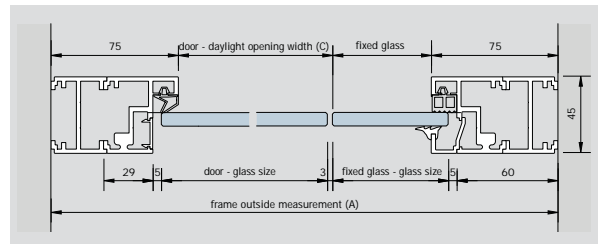

plan / door with fixed glazing
Type A

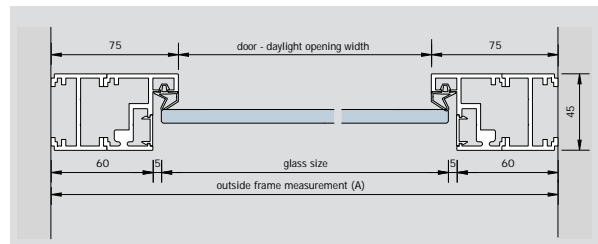

plan / door
Type B

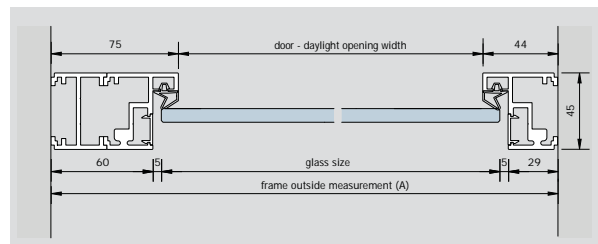

plan / door
Type C

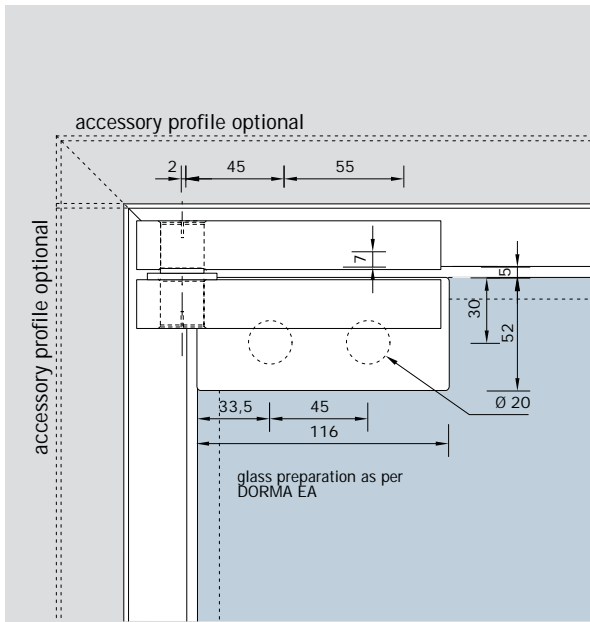

view DORMA EA top patch fitting

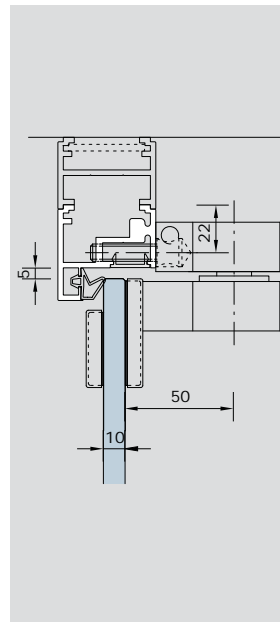

sectional cut DORMA EA
top patch fitting

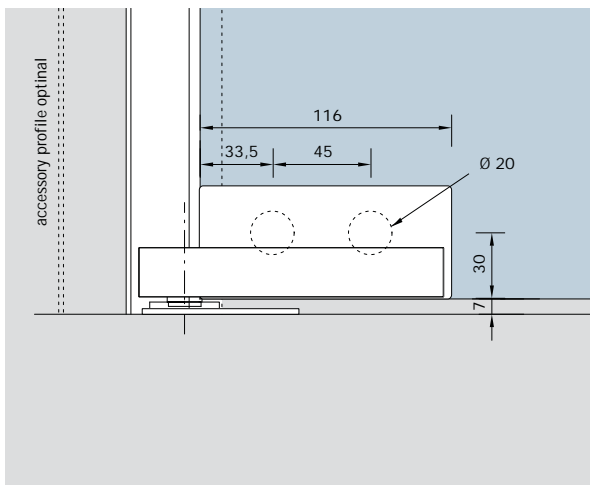
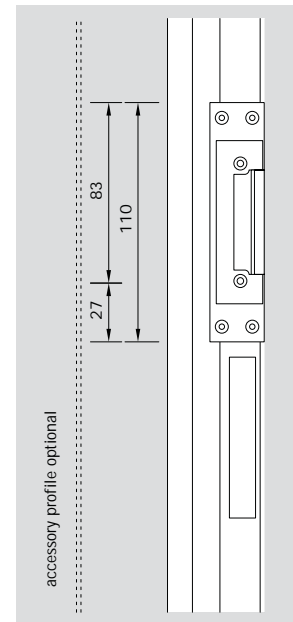

view DORMA EA with floor pivot bearing

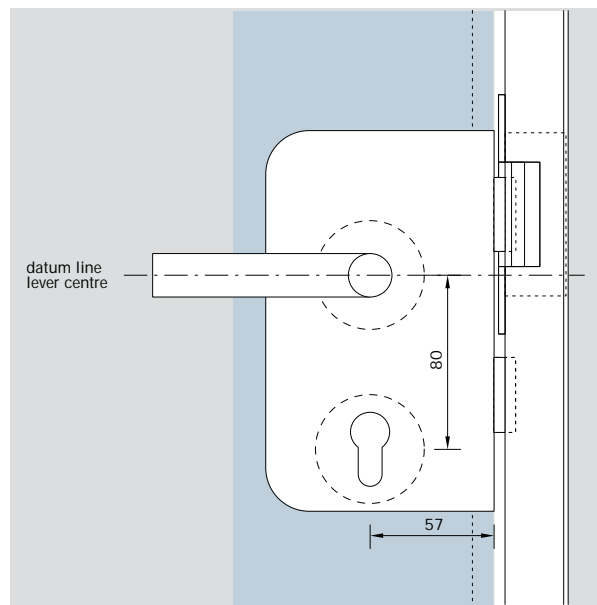

view lock Junior Office

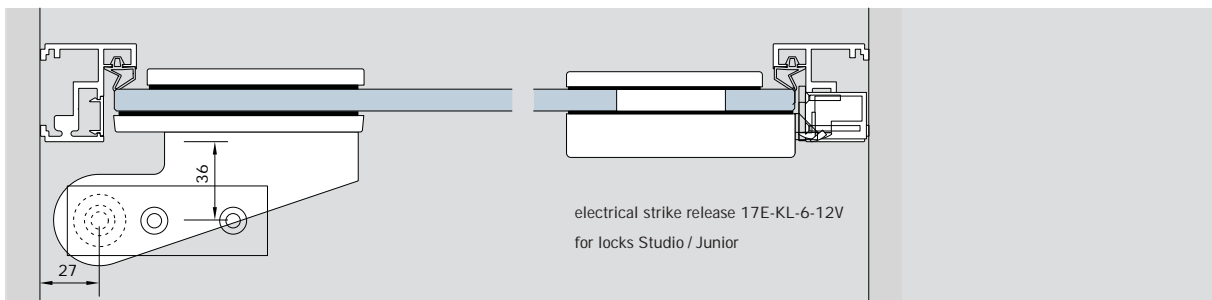

electrical strike release 17E-KL-6-12V
for locks Studio / Junior

Deubl AT 44 with DORMA EA

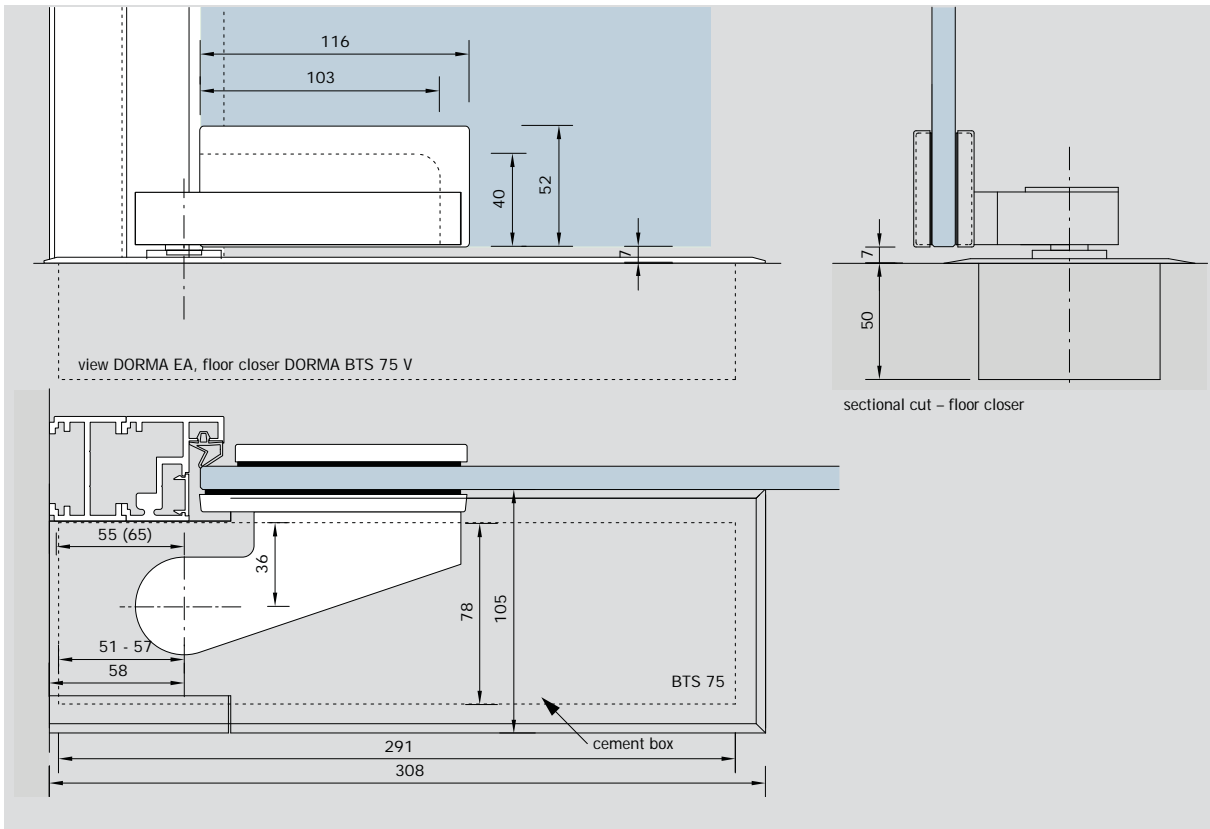
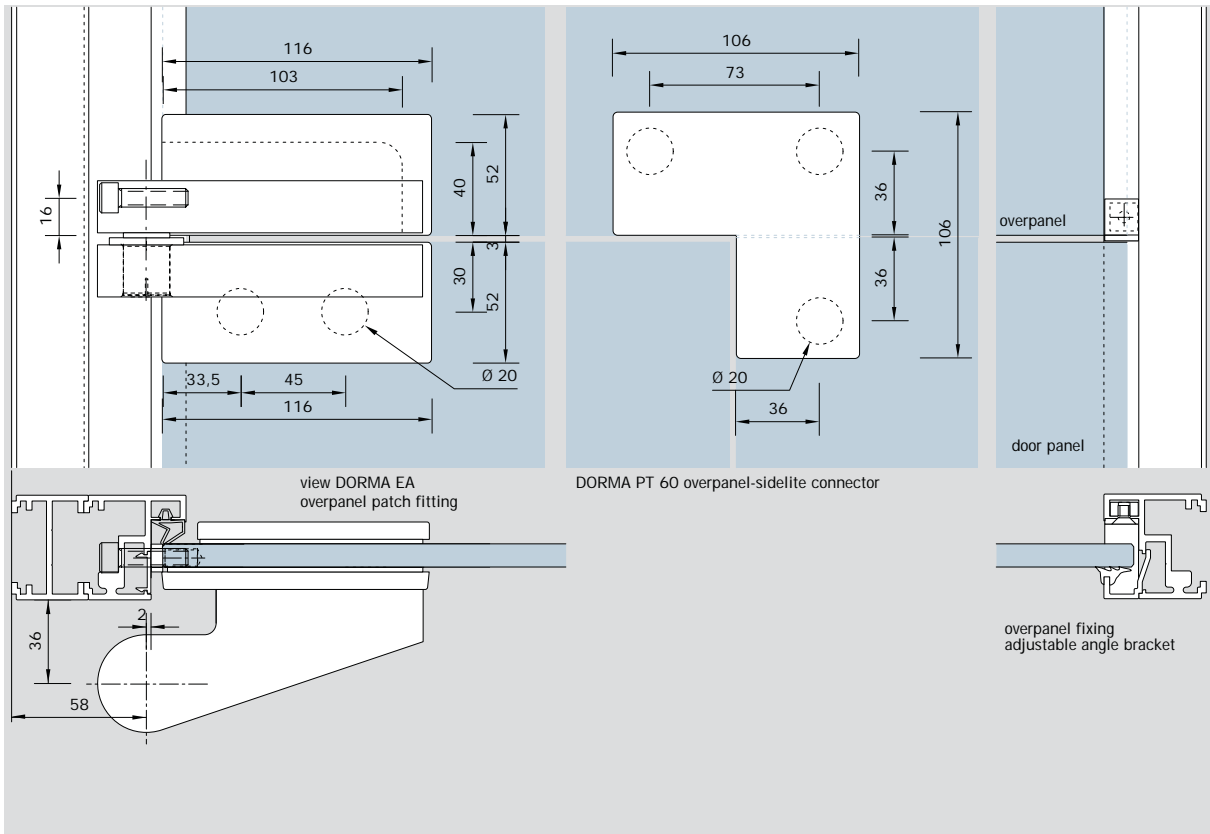

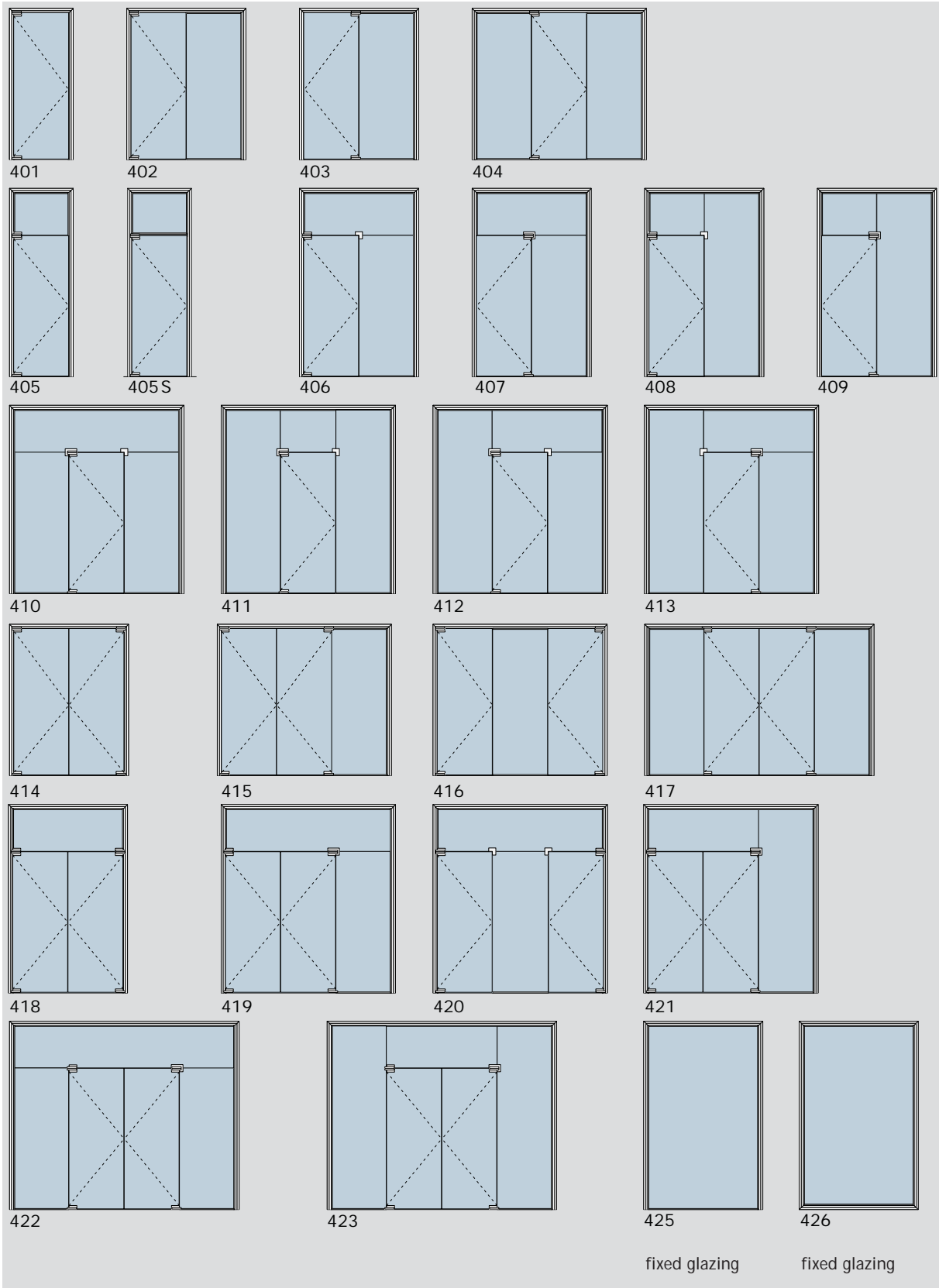

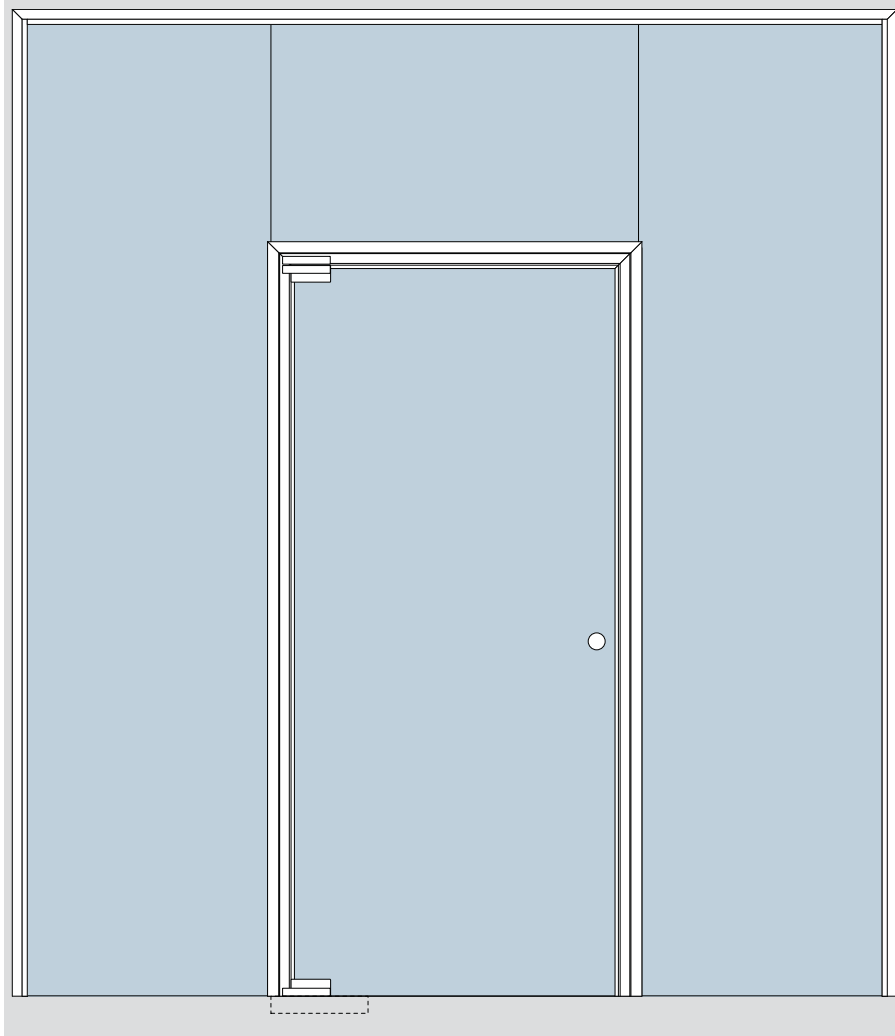

Delicate construction for fixed side lites with overpanel and centre positioned single acting door - The combination of frames Deubl AT 44 and Deubl PT 35.

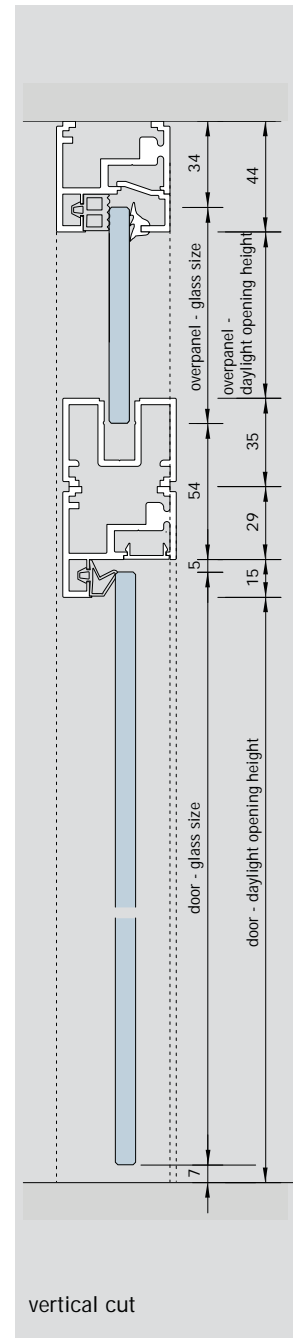

vertical cut

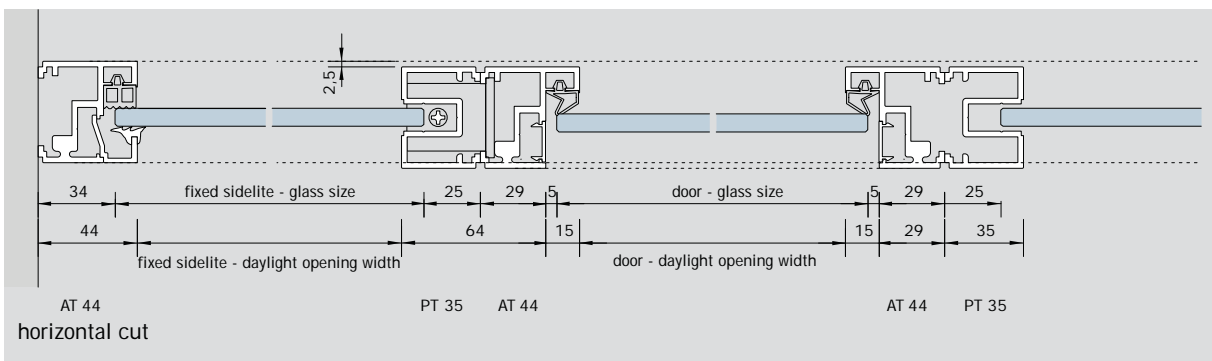

AT 44
horizontal cut

PT 35 AT 44

AT 44 PT 35

Deubl PT 35 double acting door frame

for 10 mm glass

With concealed fixing and suitable for single and double leaf door assemblies, with overpanel and/or fixed sidelite.

Suitable for DORMA Universal patch fittings with matching locks and levers.

Max. door weight
80 kg

Standard finishes
 – Satin silver anodised
 – Painted white RAL 9016
 – Similar satin stainless steel anodised

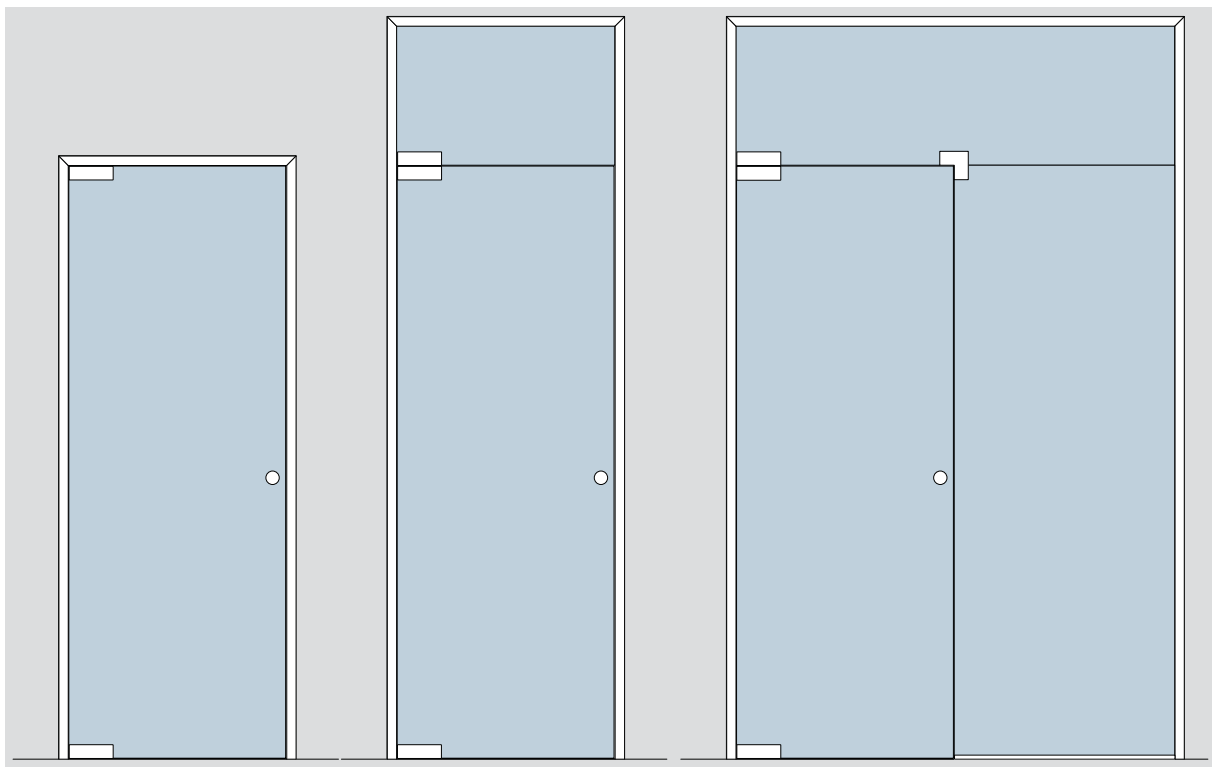
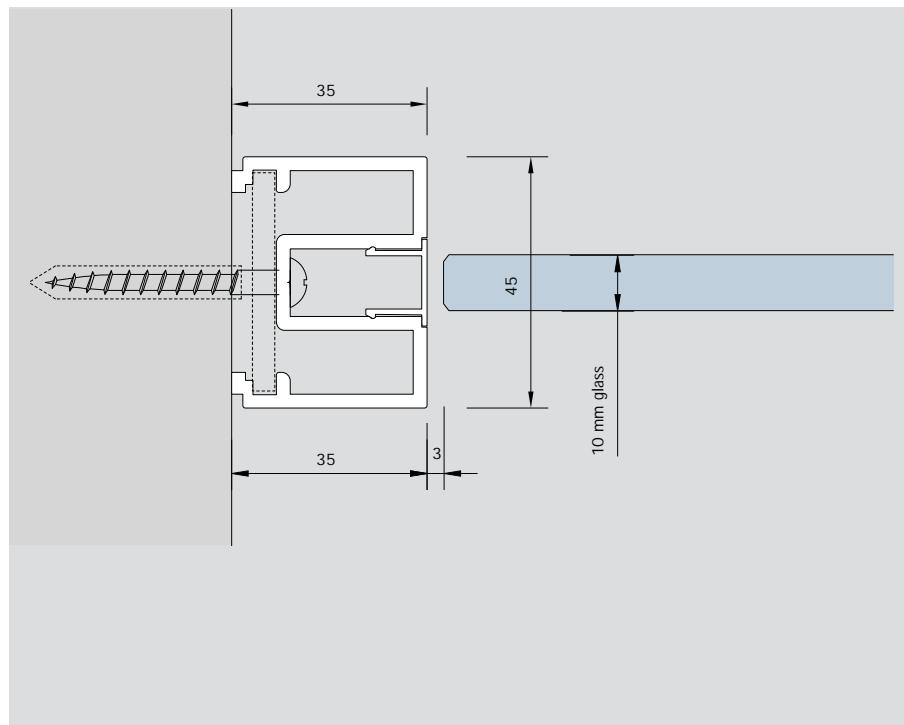

The profiles

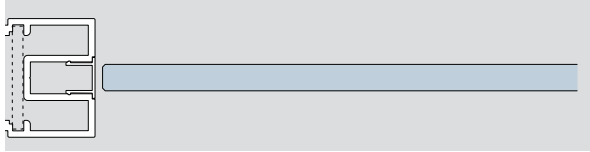

Deubl PT 35 frame profile with cover clip profile

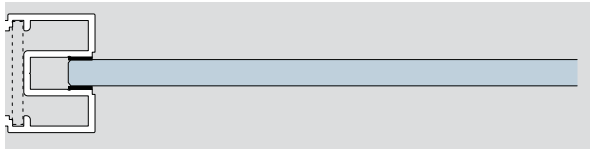

Deubl PT 35 frame profile with glass penetration



Fitting type examples

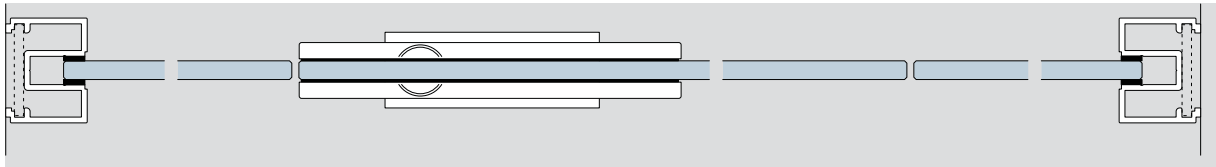

Deubl PT 35 with DORMA Universal patch fitting, floor pivot bearing

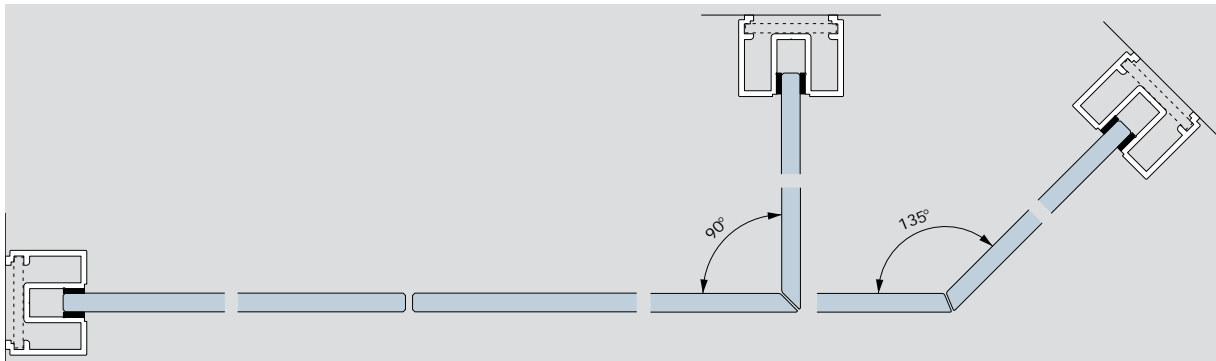

Deubl PT 35 fixed glazing

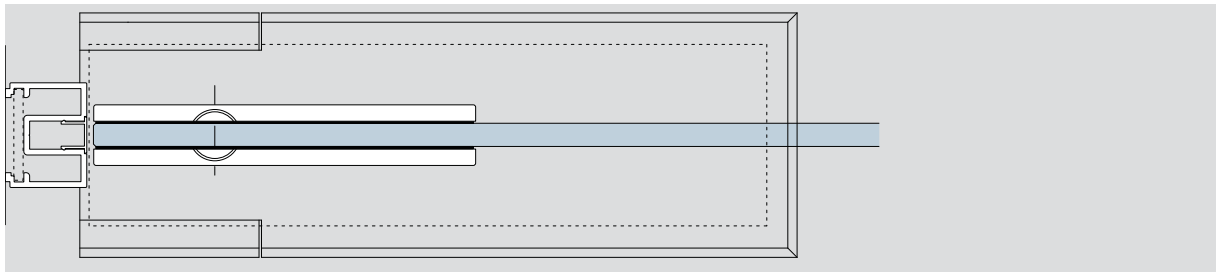

Deubl PT 35 with DORMA Universal patch fitting, floor closer BTS 75 V

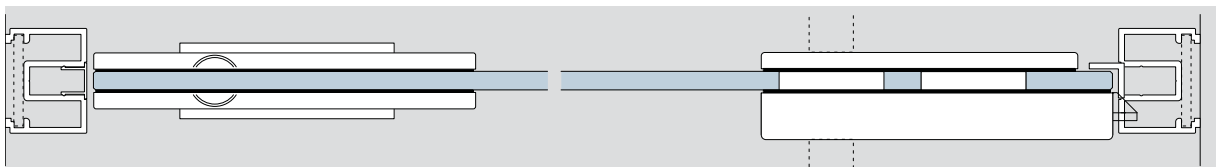

Deubl PT 35 with DORMA Universal patch fitting, floor pivot bearing

lock, Studio Rondo / Classic

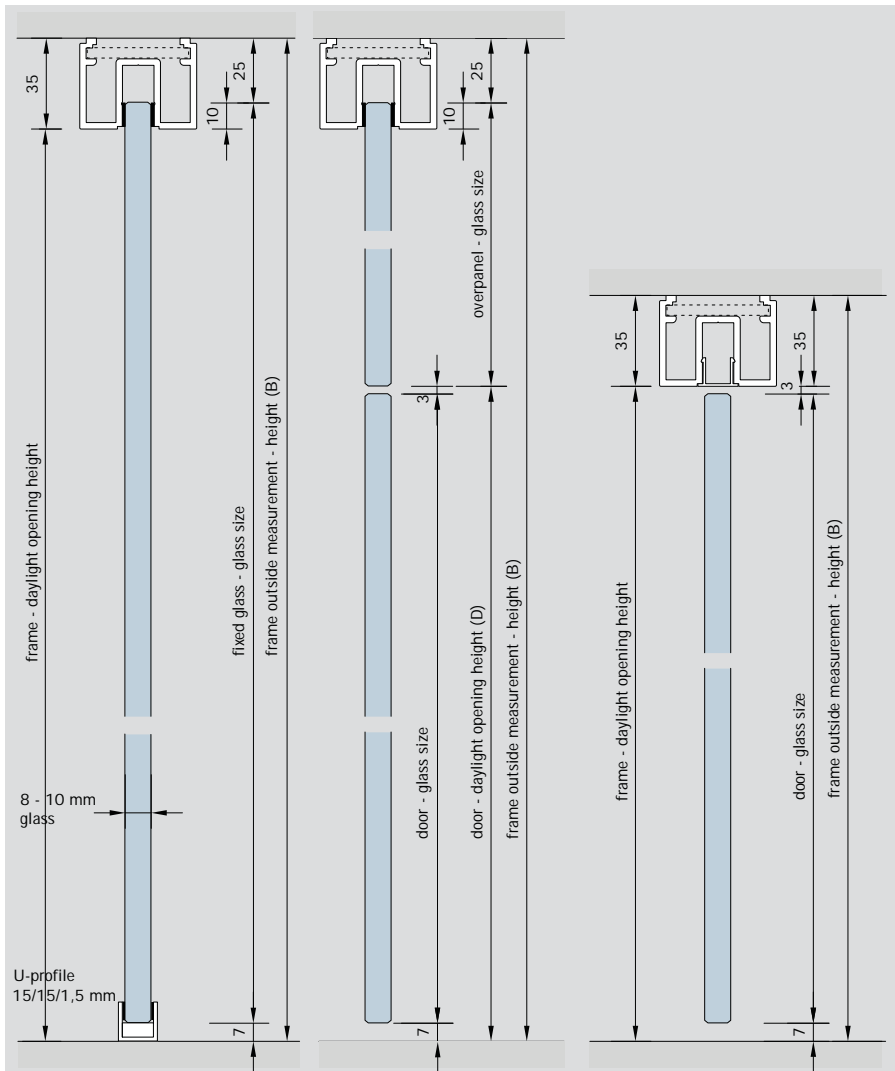

sectional cut / fixed glazing

sectional cut / door with overpanel

sectional cut / door

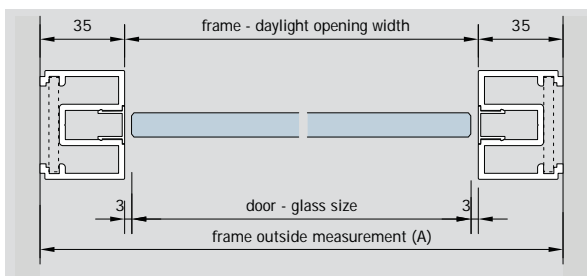

plan / door

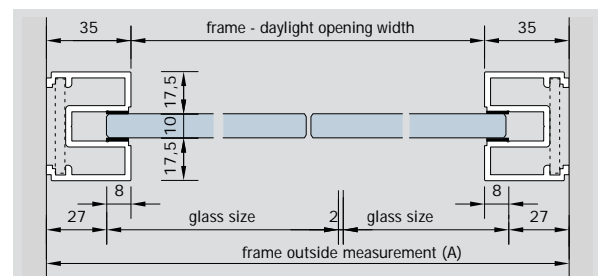

plan / fixed glazing with two elements

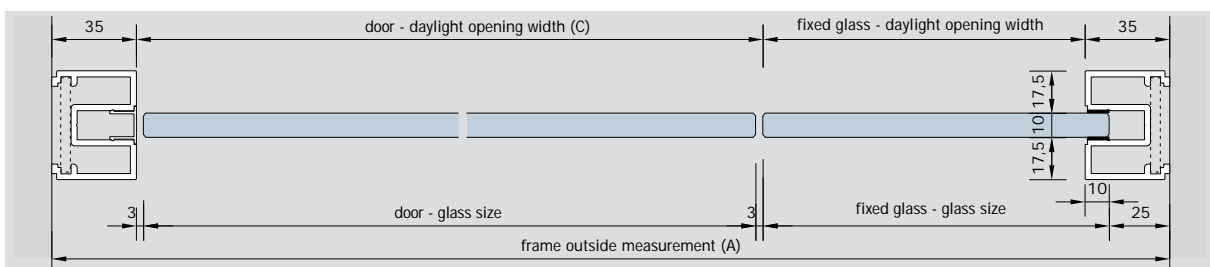

plan / door with fixed glazing

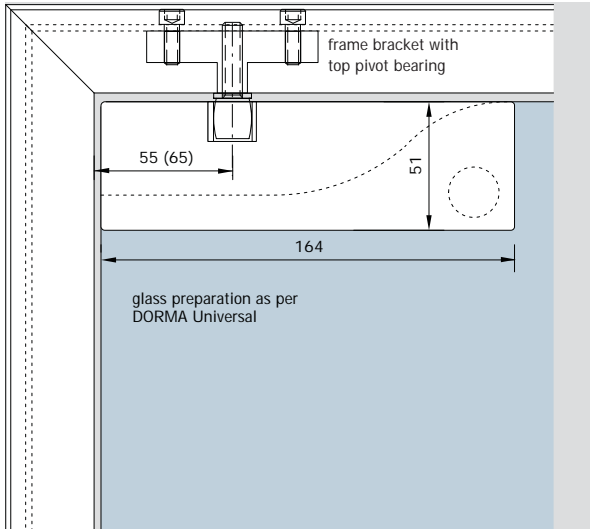

view DORMA Universal top patch fitting

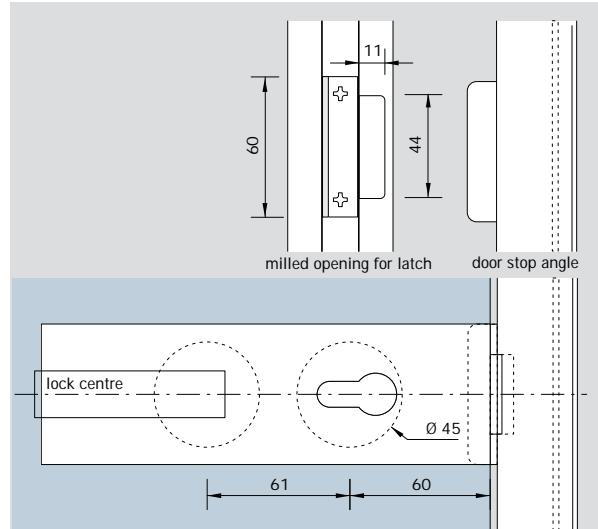

view DORMA lock Studio Classic

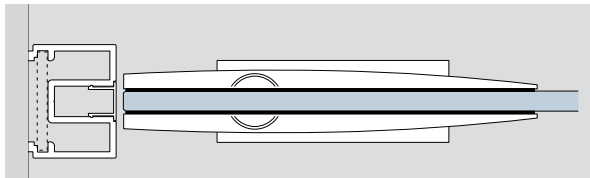

plan DORMA ARCOS Universal patch fitting

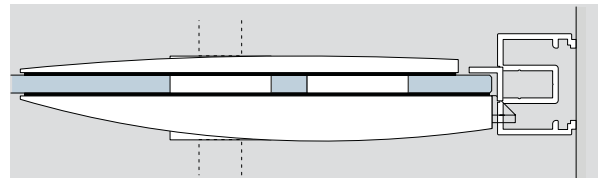

plan lock DORMA ARCOS Studio

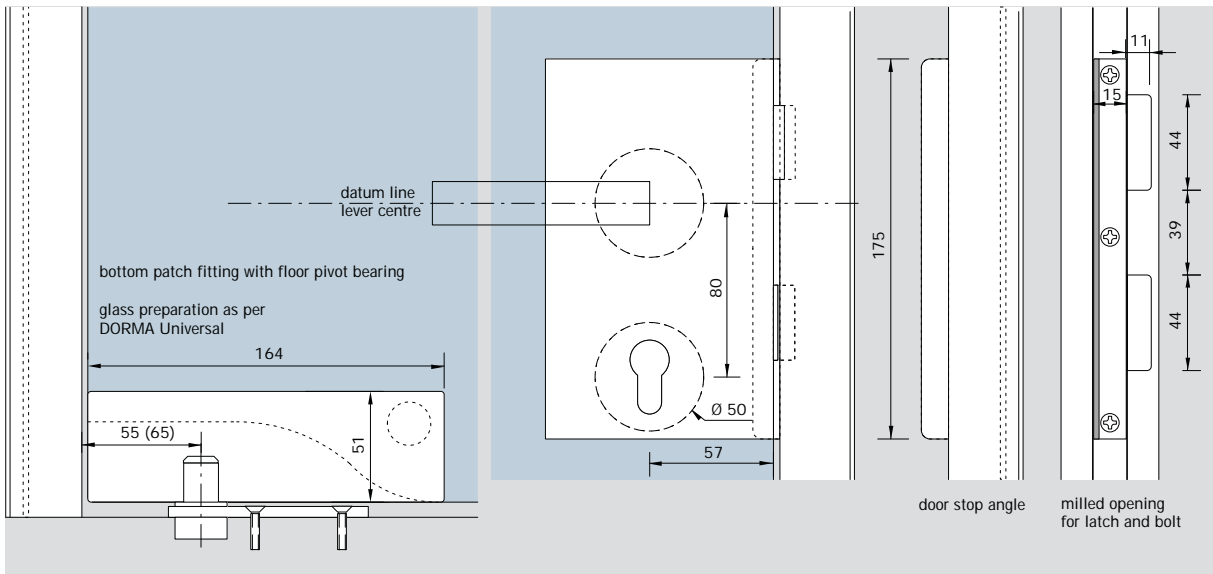

view DORMA Universal bottom patch fitting

lock DORMA Junior Office Classic

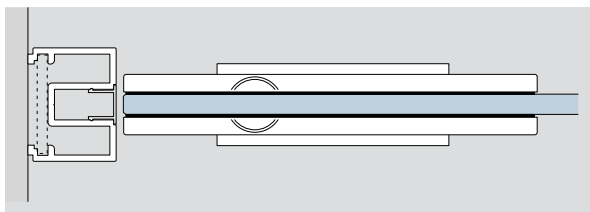

plan DORMA Universal patch fitting

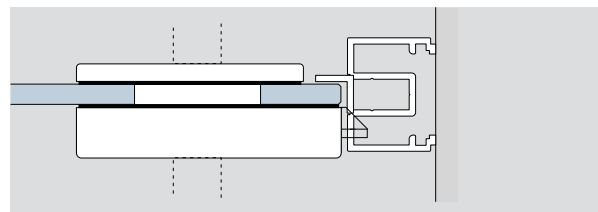

plan lock DORMA Junior Office Classic

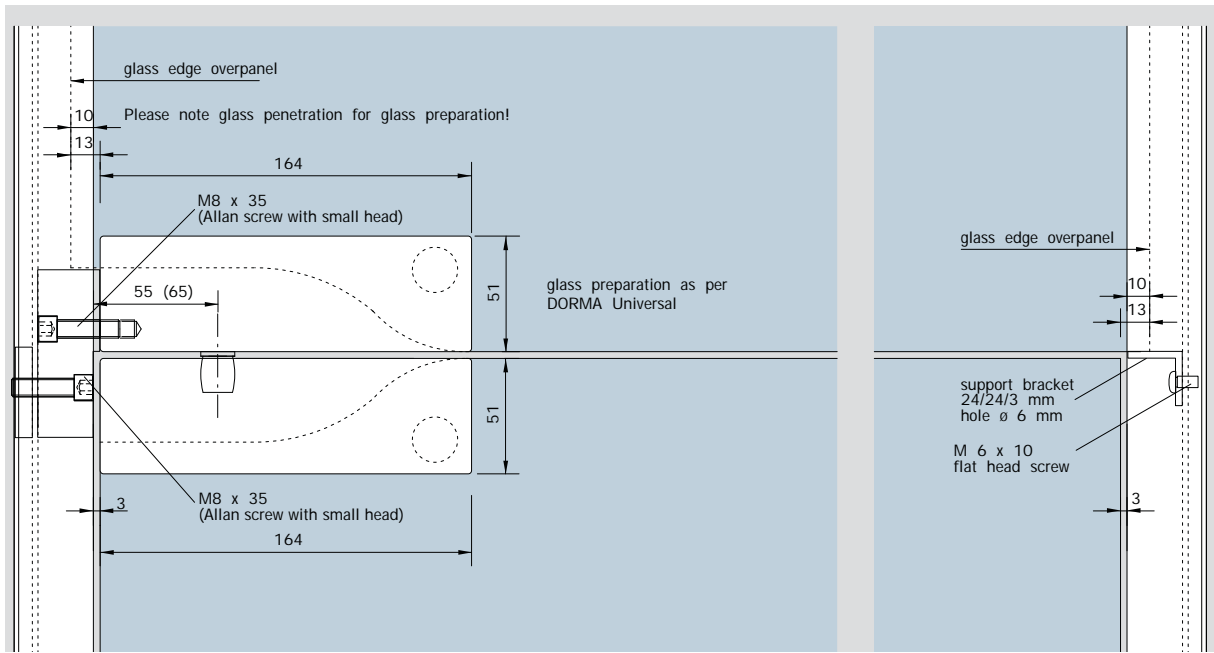

view DORMA Universal patch fitting

view overpanel support

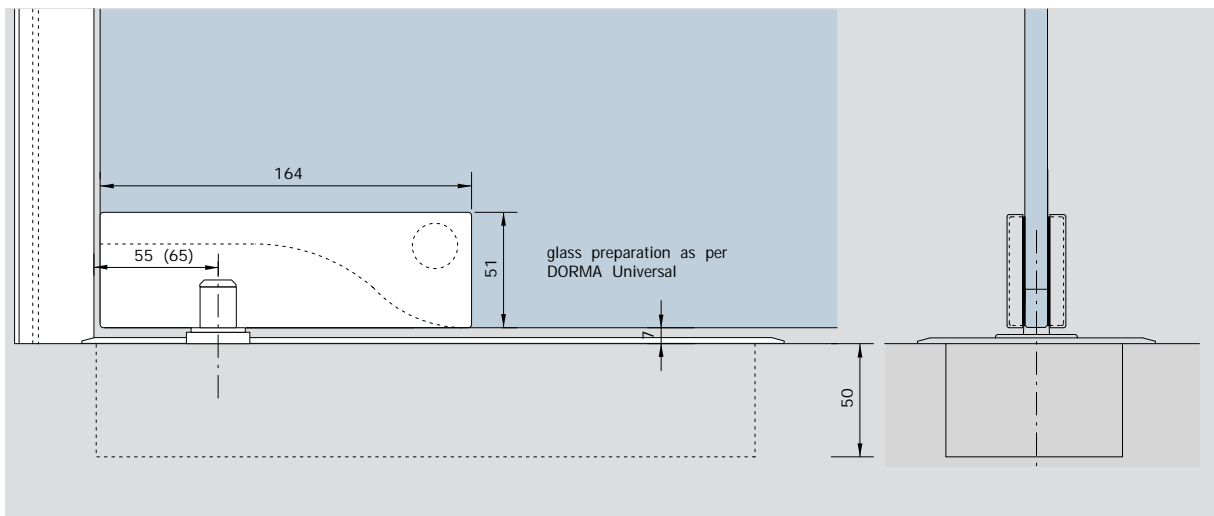

view DORMA Universal patch fitting, floor closer

sectional cut DORMA Universal patch fitting, floor closer

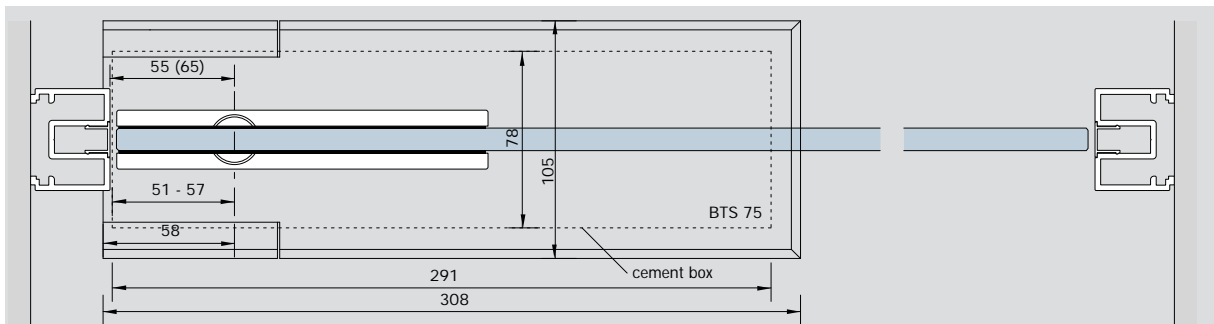

plan double acting door with DORMA BTS 75 V

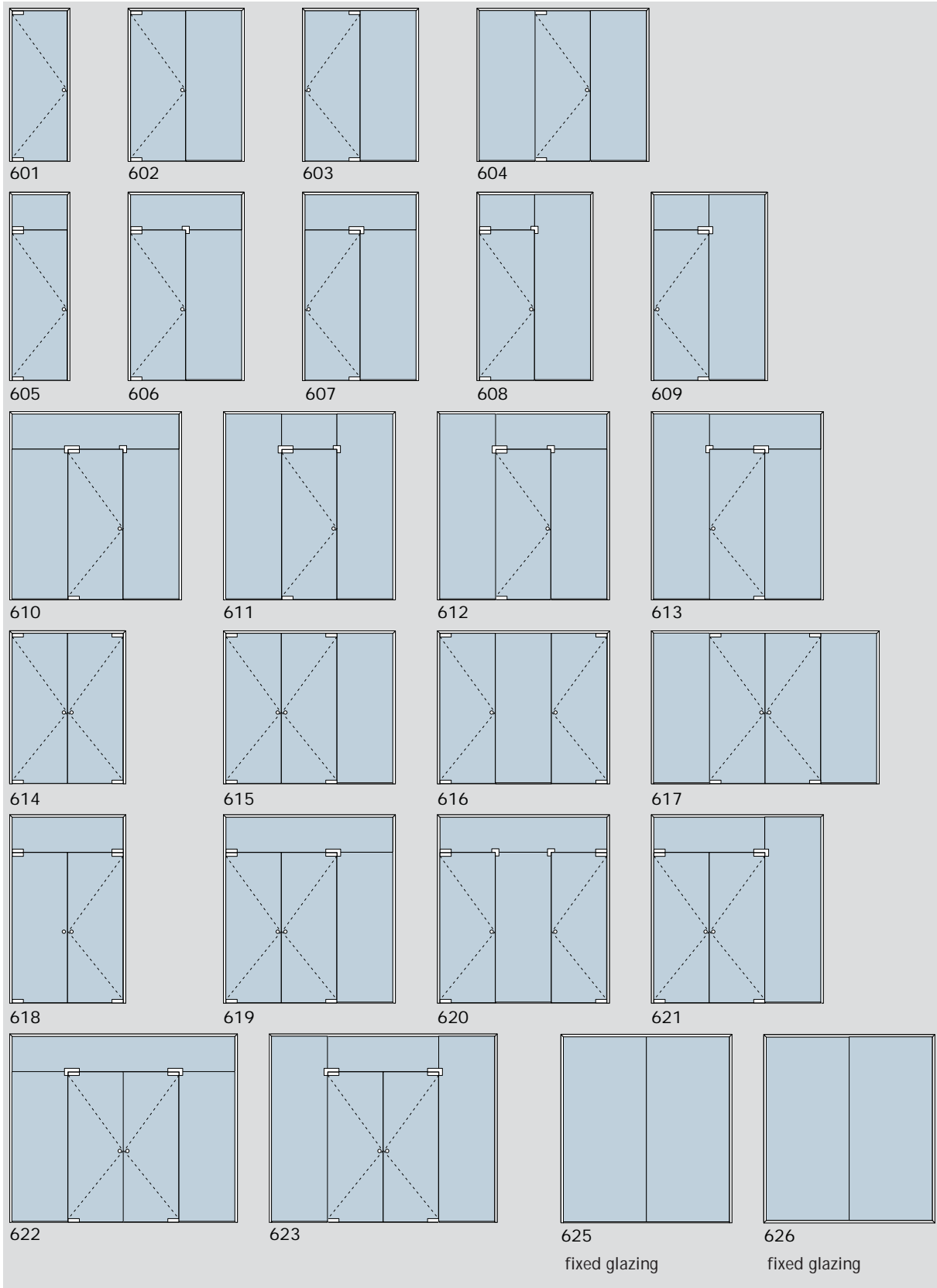

Deubl MRX 30 door frame surround

for 6 and 8 mm glass

With concealed fixing for fixed glazing.

Standard finishes

- Satin silver anodised
- Painted white RAL 9016
- Similar satin stainless steel anodised

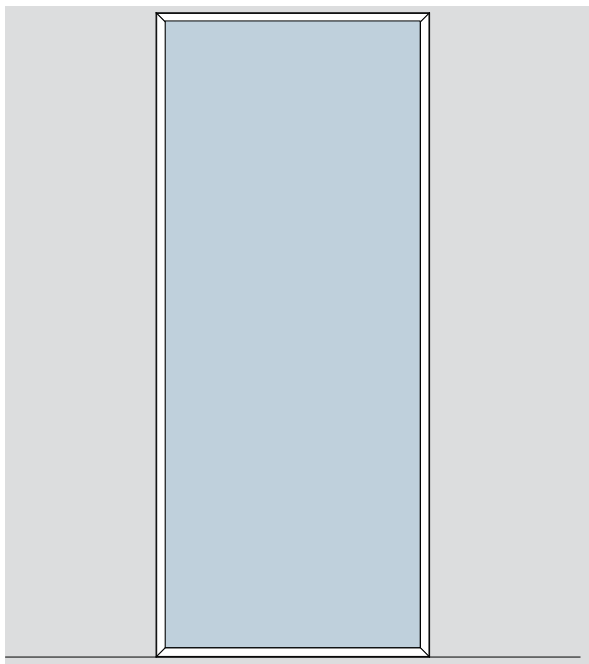
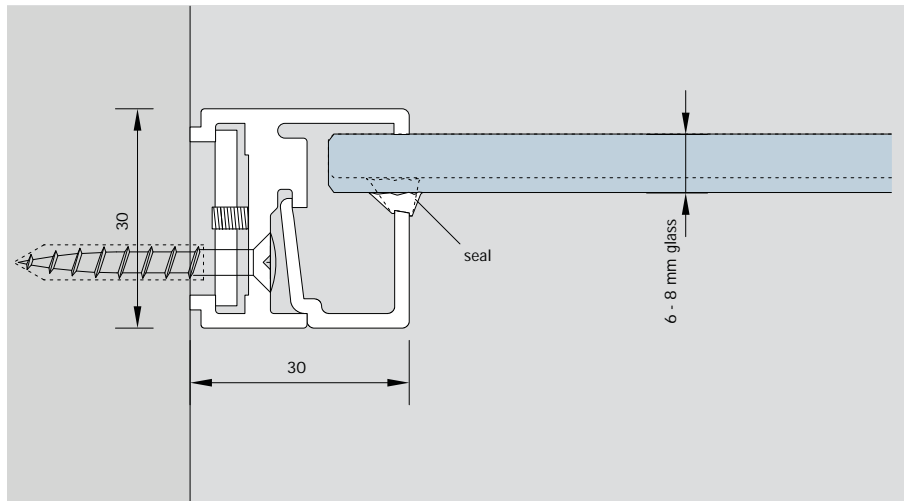

view frame - fixed glazing

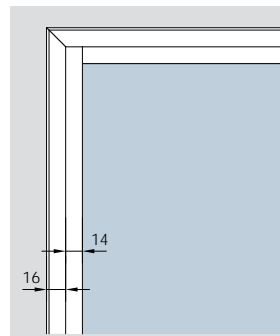

inside frame

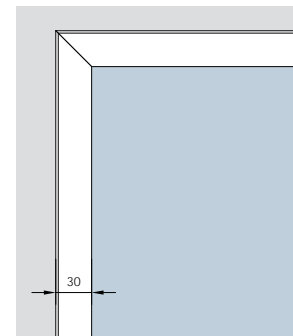

outside frame

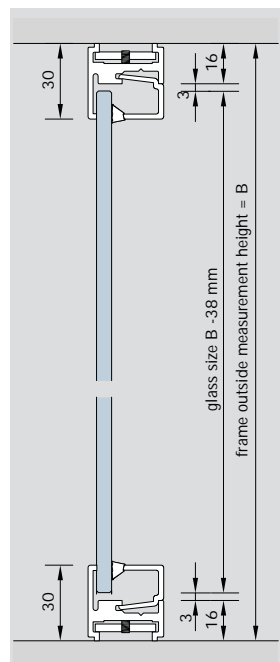

sectional cut door frame surround

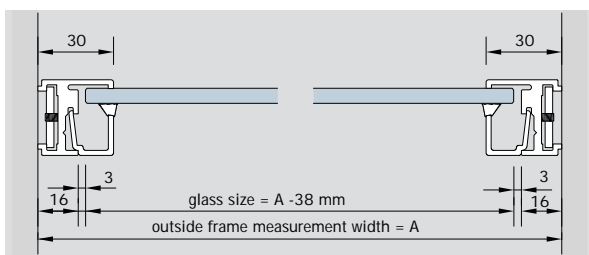

plan door frame surround

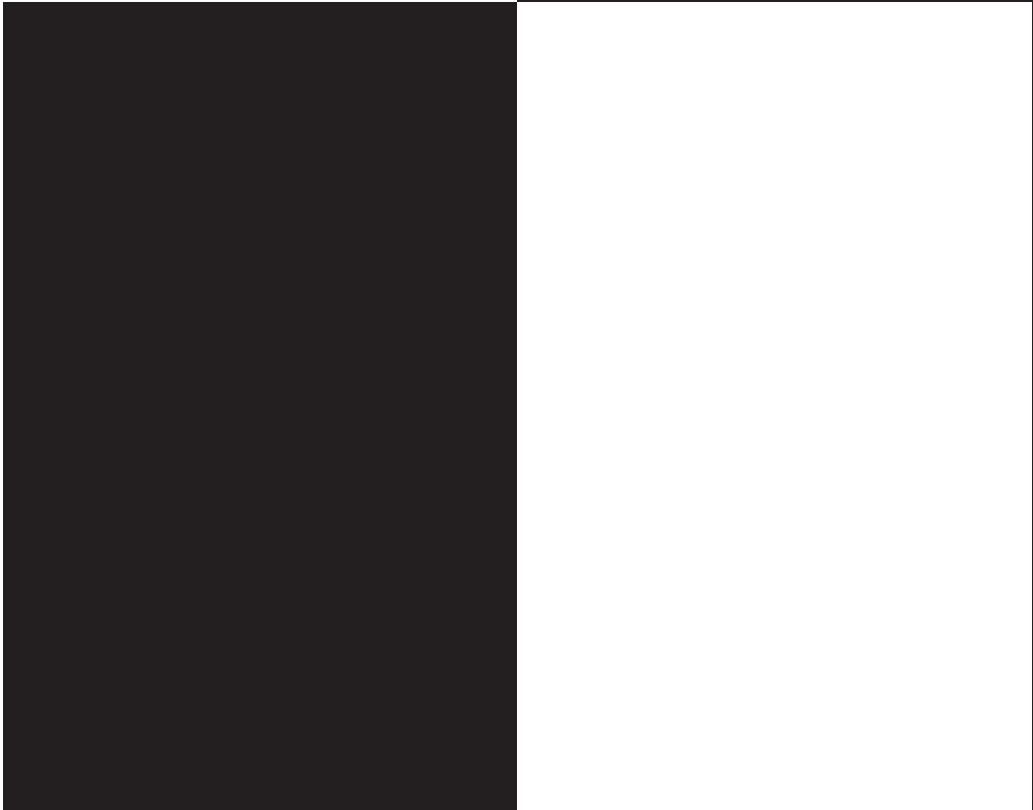

DORMA-Glas GmbH
Postfach 32 68
D-32076 Bad Salzuflen
Max-Planck-Straße 33 - 45
D-32107 Bad Salzuflen
Tel. +49 5222 924-0
Fax +49 5222 21009
www.dorma-glas.com