



Panic Hardware

DORMA PHA 2000 PHB 3000



The modular DORMA Panic Hardware System

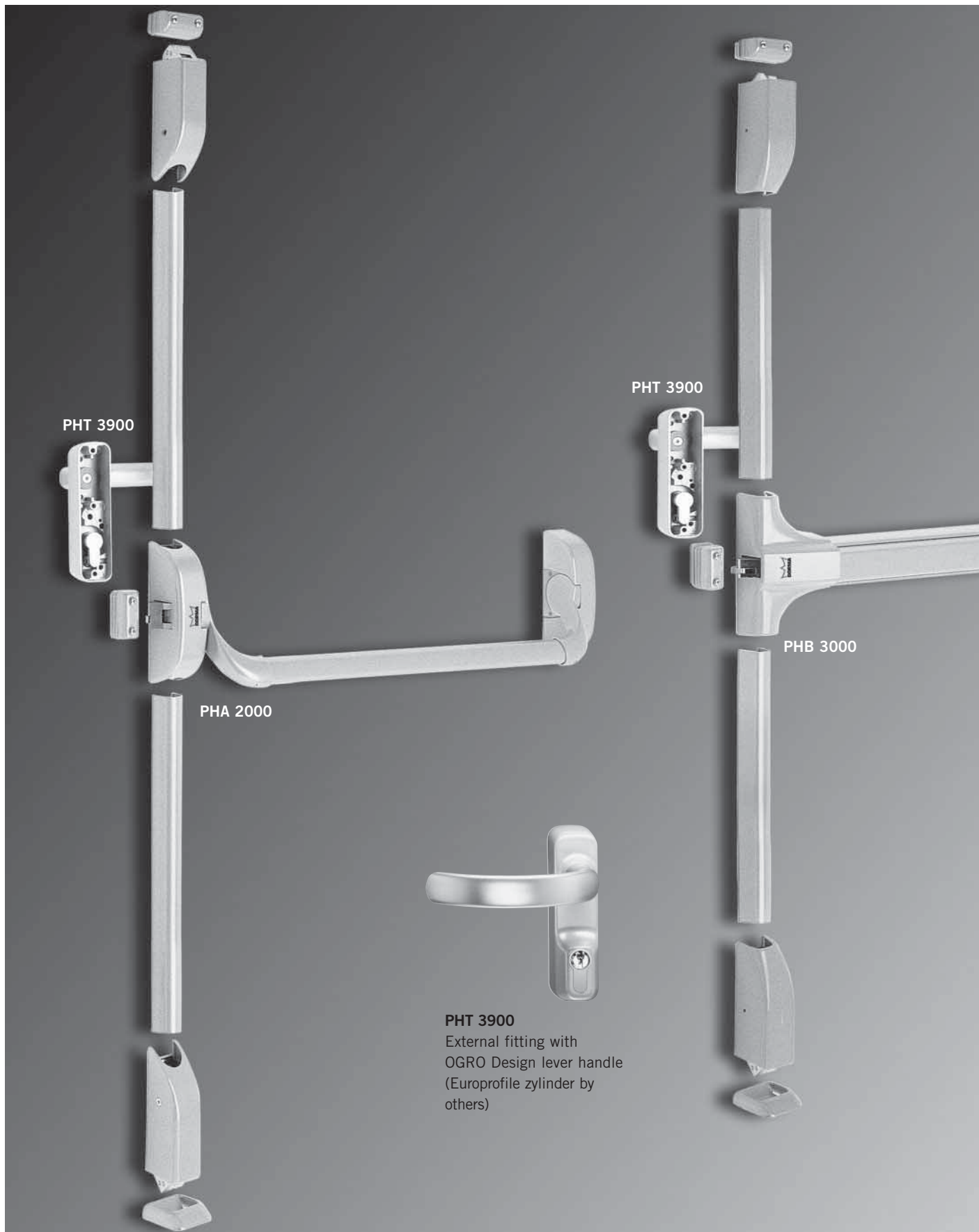

Forward-looking and innovative hardware for emergency exit doors

The DORMA Panic Hardware System offers an extensive range of high-quality panic hardware fittings with horizontal and vertical locking for use on emergency exit doors where security, reliability and aesthetic elegance are crucial requirements. DORMA PHA, PHB and PHT products fully

meet the demands that are made on fittings used in public buildings, for example, in hospitals, universities and schools, concert halls, shopping centres, hotels and offices.

The same DORMA PHT external fittings can be used in conjunction with both series.

Approval certification

The Panic Hardware products in the DORMA PHA 2000 and PHB 3000 series have been tested and approved to EN 1125 and carry the **CE** conformity mark in accordance with supplement ZA to that Standard.



Additional information on many products can be found at www.dorma.com. The abbreviated codes next to the computer symbol  indicate the search terms.

Contents

	Page
DORMA PH Series 2000/3000	
Features and functions	4
DORMA PHA Series 2000	
Applications and fixing details	6
DORMA PHA Series 2000	
Components	8
DORMA PHB Series 3000	
Applications and fixing details	12
DORMA PHB Series 3000	
Components	14
DORMA PH	
Accessories	18
DORMA PHT 3900	
External fittings	22

Practical panic hardware for diverse door applications

The DORMA PHA Series 2000 Crossbar, the PHB Series 3000 Pushbar and the universally applicable Series 3900 external fittings, offer a range of products that can be used on both narrow-stile doors as well as on timber doors.

The wide security latchbolt engages in a keep that is normally mounted on the frame. This ensures that the latch is extremely easy to mount and that the door is also securely locked.

Benefits

For the trade

- Modular system for reduced storage costs
- Non-handed
- Universal use of PHT 3900 external fittings

For the installer

- Straightforward fixing
- Easy adjustment to different door widths and heights

For the architect/specifier

- For horizontal and vertical panic lock mechanisms
- External fitting with OGRO Design lever handle or knob
- Electrical functions for special applications

For the user

- Simple operation
- Excellent quality ensures a long lifespan
- Universal door opener

Data and features	PHA Series 2000			PHB Series 3000		
	1 point	2 point	3 point	1 point	2 point	3 point
Modular System	●	●	●	●	●	●
Standard (not expandable)	–	●	–	●	–	–
Standard doors (single-leaf / double-leaf)	●	●	●	●	●	●
Fire and smoke check doors (single-leaf / double-leaf) F	●	●	●	●	●	●
Door width	≤ 1000 mm	●	●	●	●	●
	≤ 1300 mm	●	●	●	●	●
Door height	≤ 2270 mm		●			
	≤ 3400 mm ¹⁾		●			
	≤ 2265 mm				●	●
	≤ 3200 mm ¹⁾				●	●
Max. Door weight (in kg)	200	200	200	200	200	200
Non-handed design	●	●	●	●	●	●
Dogging device ²⁾	●	●	●	●	●	●
Security Anti-thrust latch	for Standard doors			●	●	●
	for Fire and smoke check doors	●	●	●	●	●
Electrical unlocking via electric strike	○	○	○	○	○	○
Monitoring switch on pushbar	○	○	○	○	○	○
External fittings PHT 3900						
For Standard doors and Fire and smoke check doors	●	●	●	●	●	●
For door leaf thickness up to 60 mm						
Extended handle spindle and bolts for door leaf thickness 60 – 105 mm	○	○	○	○	○	○
Approved to EN 1125	●	●	●	●	●	●
CE mark for building products	●	●	●	●	●	●

● = yes – = no ○ = option

¹⁾ Doors higher than 2500 mm lie outside the scope of EN 1125.

²⁾ Not for Fire and smoke check doors.

F Approval certification

The DORMA Panic Hardware Series PHA 2000 products marked with the **F** symbol have been tested for use on fire and smoke check doors.

Test reports and/or certificates are available on request.

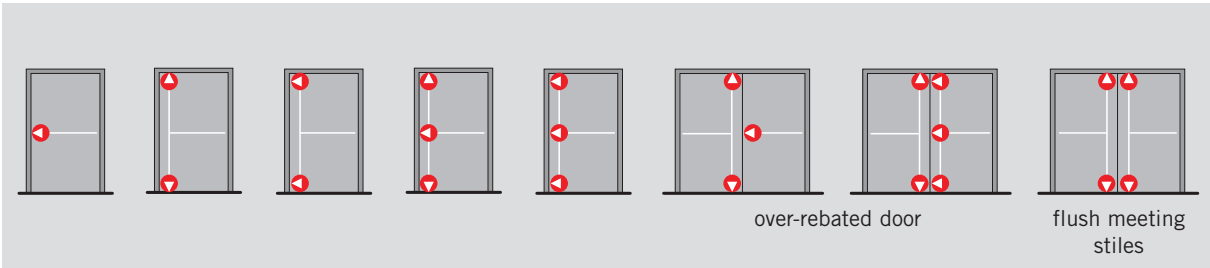

The modular Panic Hardware System

PHA 2000

PHB 3000



Single-point locking

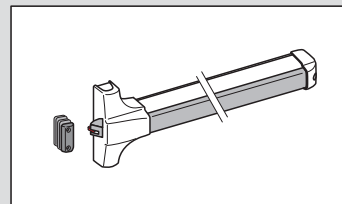
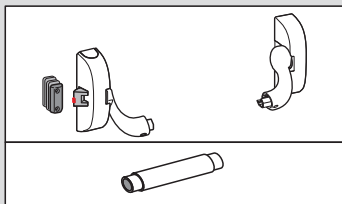

+

Two-/three-point locking

+

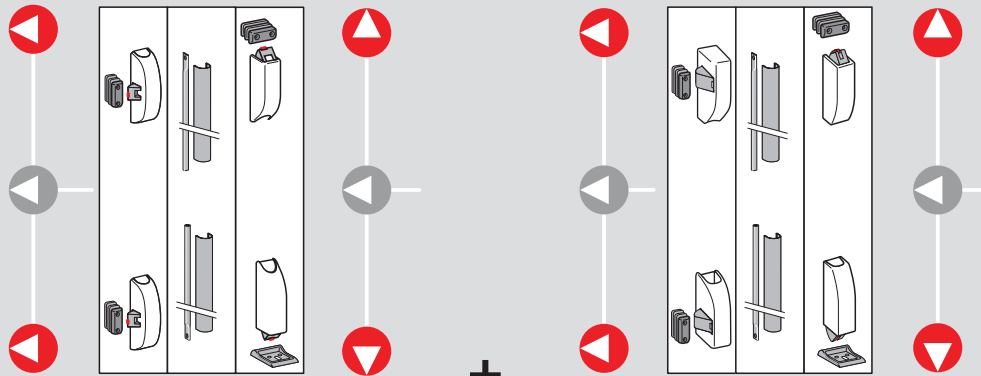

+
PHT

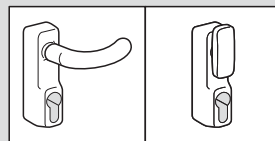

Security anti-thrust latch

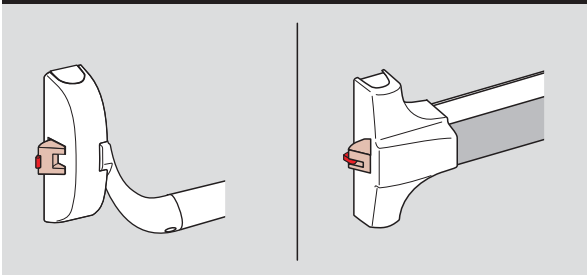

The security anti-thrust latch prevents the latch from being pushed back by unauthorised means when it is in the closed position.

Dogging device

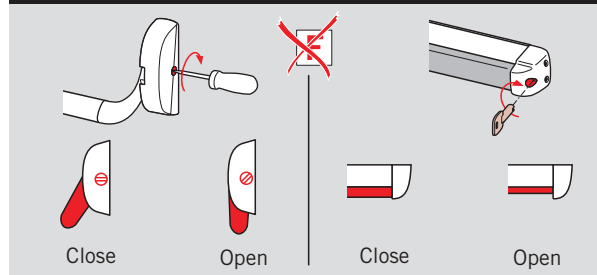

The dogging device serves to hold the latch in its retracted position, so the door is freely accessible.

Single-point locking

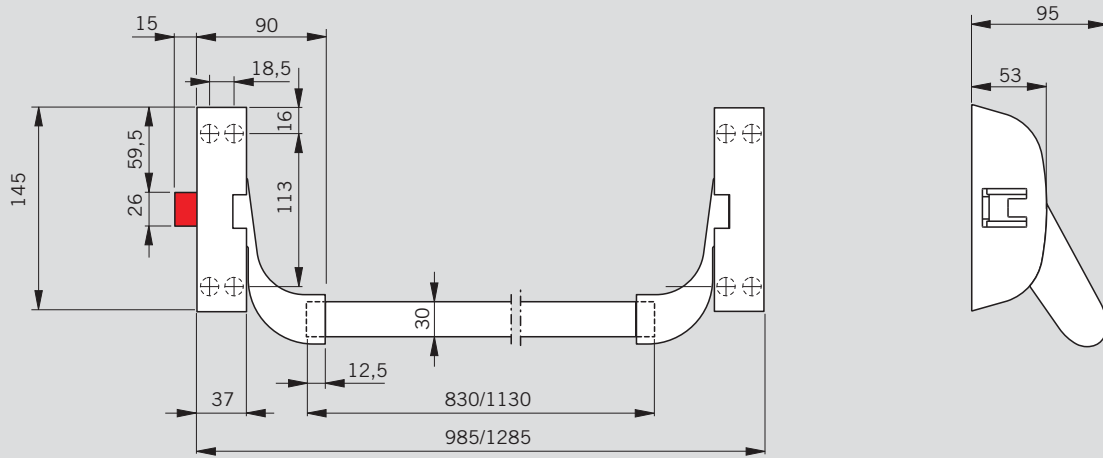

Two/three-point locking

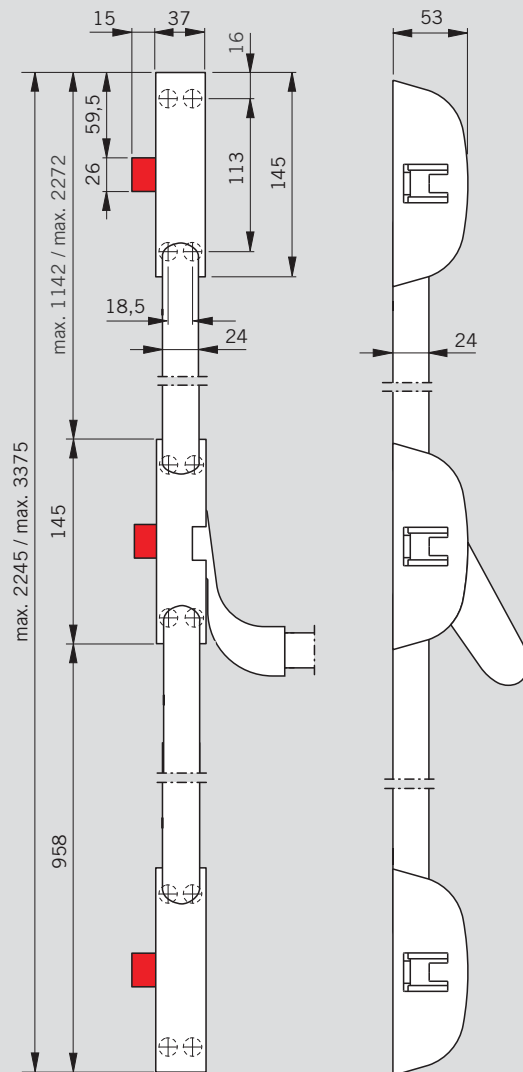
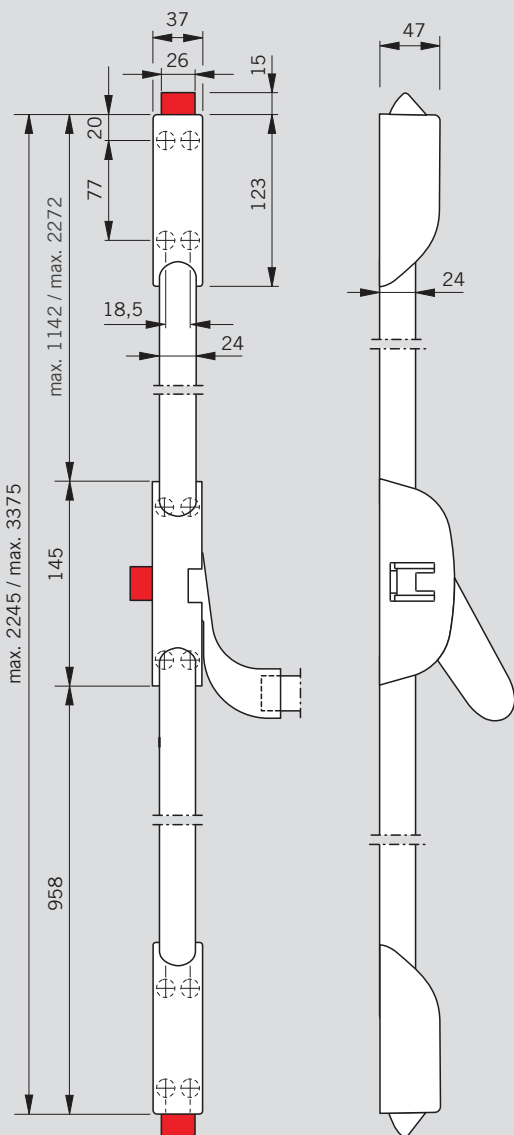

Applications and fixing details

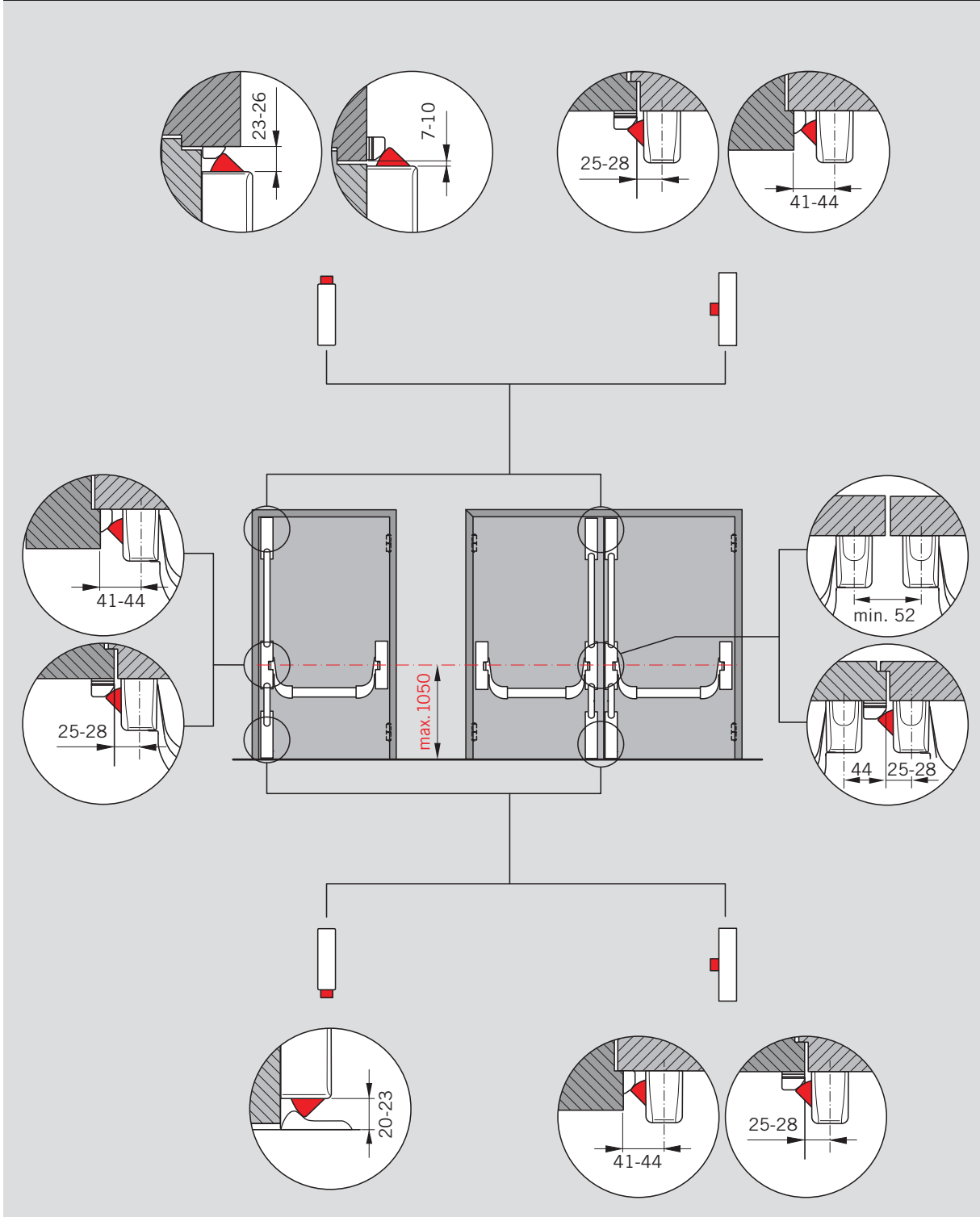

Note:

It may be the case that the panic fitting cannot be installed on extreme door situations according to standard measurements (door width X smaller than

1000 mm in connection with the distance of the hinge Y bigger than 90 mm). On request DORMA will gladly give you installation suggestions.

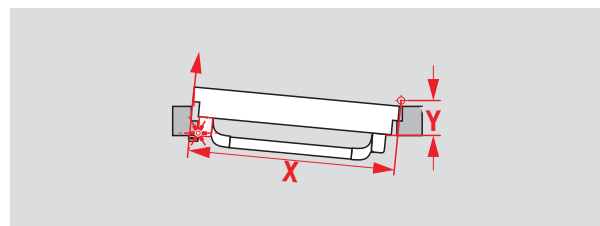

Components on single-leaf doors

Standard doors	Modular 2101	●	●	●	●	●
	Standard 2201		○	○		
	2104 / 05	●	●	●	●	●
	2204 / 05		●	●	●	●
	2202 2206		●		●	
Fire and smoke check doors F	Modular 2102	●	●	●	●	●
	Standard 2201		○	○		
	2104 / 05	●	●	●	●	●
	2204 / 05		●	●	●	●
	2203 2207		●		●	

F Approval certification

The DORMA Panic Hardware Series PHA 2000 products marked with the **F** symbol have been tested for use on fire and smoke check doors. Test reports and/or certificates are available on request.



The DORMA Panic Hardware Series PHA 2000 carry the **CE**-conformity mark.

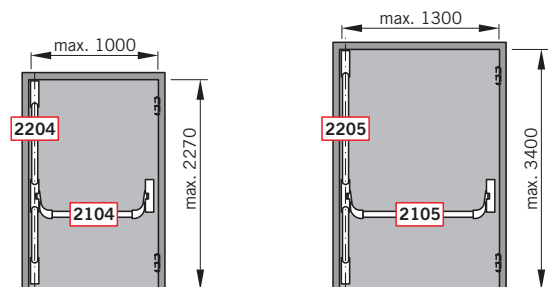

Components on double doors

over-rebated door		flush meeting stiles		flush meeting stiles		
Inactive leaf	Active leaf	Inactive leaf	Active leaf	Inactive leaf	Active leaf	
●	●	●	●	●	●	2101 Modular
○		○		○	○	2201 Standard
●	●	●	●	●	●	2104 / 05
●		●	●	●	●	2204 / 05
●		●		●	●	2202
			●		●	2206
●	●	●	●	●	●	2102 Modular
○		○		○	○	2201 Standard
●	●	●	●	●	●	2104 / 05
●		●	●	●	●	2204 / 05
●		●		●	●	2203
			●		●	2207

○ = option

External trims see page 22/23

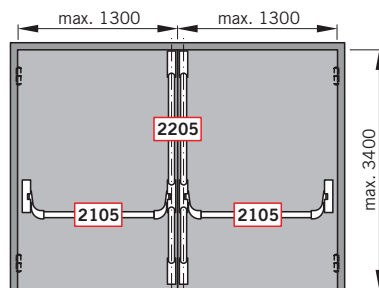
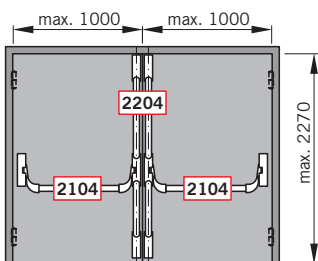

Note:

According to EN 1125 the effective length of the operating bar has to be at least 60 % of the door width. Doors higher than 2500 mm lie outside the scope of EN 1125.

Specification text

PHA Series 2000

Panic door bolt tested in accordance with EN 1125, for door widths up to 1300 mm, door heights up to 2270 (in accordance with EN 1125) or 3400 mm; reversible for use on LH/ISO 6 and RH/ISO 5 doors.
Can be unlocked electrically via electric strike. All products of the Panic Hardware series PHA 2000 carry the **CE** mark.

PHA 2101

Single-point locking, modular, for standard doors, without security anti-thrust latch, with dogging device. Die-cast zinc latch, zinc latch keep with spacer plates, plastic mounting backplate.

- silver colour
- black
- white

..21010001
..21010002
..21010010  PHA 2101

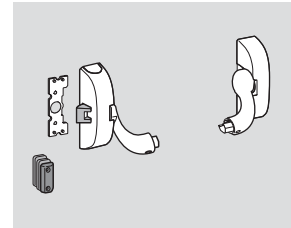
**PHA 2102 **

Single-point locking, modular, for fire and smoke check doors, with security anti-thrust latch and dogging device. Steel latch, steel latch keep with spacer plates, plastic mounting backplate.

- silver colour
- black
- white
- stainless steel design

..21020001
..21020002
..21020010
..21020004  PHA 2102

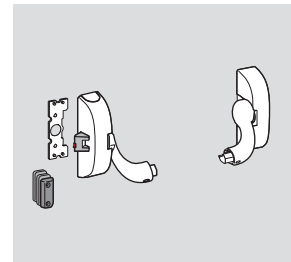
**PHA 2201**

Two-point locking only, with dogging device. Plastic mounting backplate.

- silver colour
- black

..22010001
..22010002  PHA 2201

**PHA 2104**

Connecting rod 830 mm (for door widths up to 1000 mm)

- silver colour
- red
- black
- white

..21040001
..21040002
..21040019
..21040010  PHA 2104

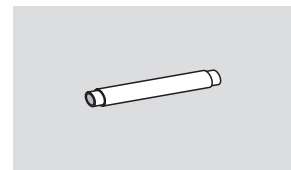
**PHA 2105**

Connecting rod 1130 mm (for door widths up to 1300 mm)

- silver colour
- red
- black
- white
- stainless steel design

..21050001
..21050002
..21050019
..21050010
..21050004  PHA 2105

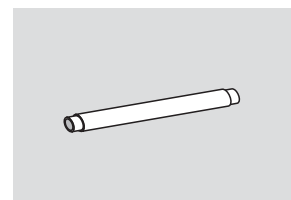

See page 18 for accessories like adjustable keeps, electric door opener or micro switch.

Specification text
Order No. 35014 .. 
PHA 2202

Top and bottom lock combination, without security anti-thrust latch. Die-cast zinc latch, zinc top latch keep with spacer plates, steel bottom latch keep.

- silver colour
- black
- white

..22020001
 ..22020002
 ..22020010  PHA 2202

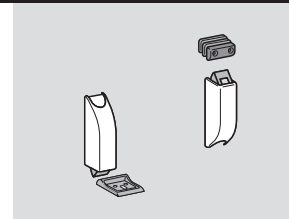
PHA 2203 

Top and bottom lock combination, for fire and smoke check doors, with security anti-thrust latch. Steel latch, steel top latch keep with spacer plates, steel bottom latch keep.

- silver colour
- black
- white
- stainless steel design

..22030001
 ..22030002
 ..22030010
 ..22030004  PHA 2203

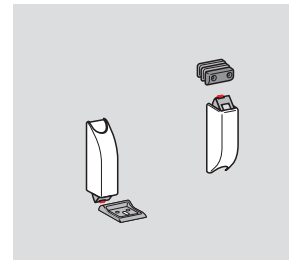
PHA 2206

Top and bottom locking combination with lateral latch, without security anti-thrust latch. Die-cast zinc latch, steel latch keeps with spacer plates.

- silver colour
- black
- white

..22060001
 ..22060002
 ..22060010  PHA 2206

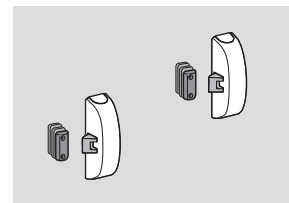
PHA 2207

Top and bottom locking combination with lateral latch, for fire and smoke check doors, with security anti-thrust latch. Steel latch, steel latch keeps with spacer plates.

- silver colour
- black
- white
- stainless steel design

..22070001
 ..22070002
 ..22070010
 ..22070004  PHA 2207

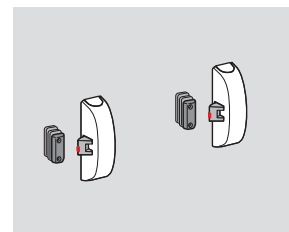
PHA 2204

Connecting rod set with cover for door heights up to 2270 mm. Steel latch keep with spacer plates for double doors.

- silver colour
- black
- white
- stainless steel design

..22040001
 ..22040002
 ..22040010
 ..22040004  PHA 2204

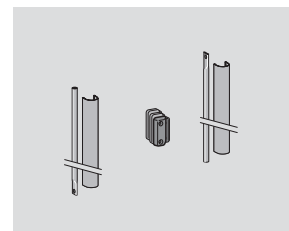
PHA 2205

Connecting rod set with cover for door heights up to 3400 mm. Steel latch keep with spacer plates for double doors.

- silver colour
- black
- white
- stainless steel design

..22050001
 ..22050002
 ..22050010
 ..22050004  PHA 2205

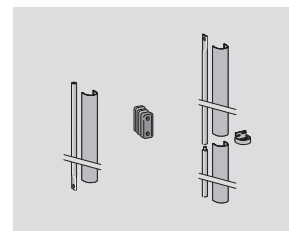

Single-point locking

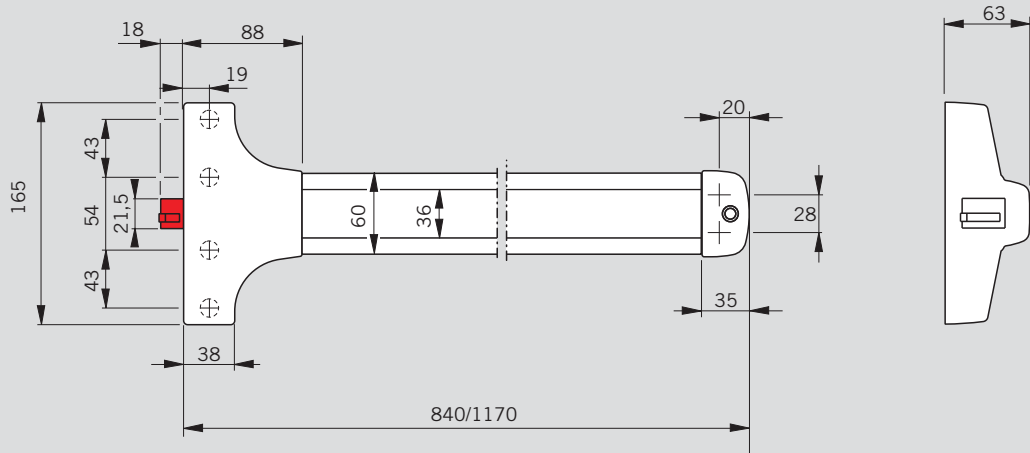

Two/three-point locking

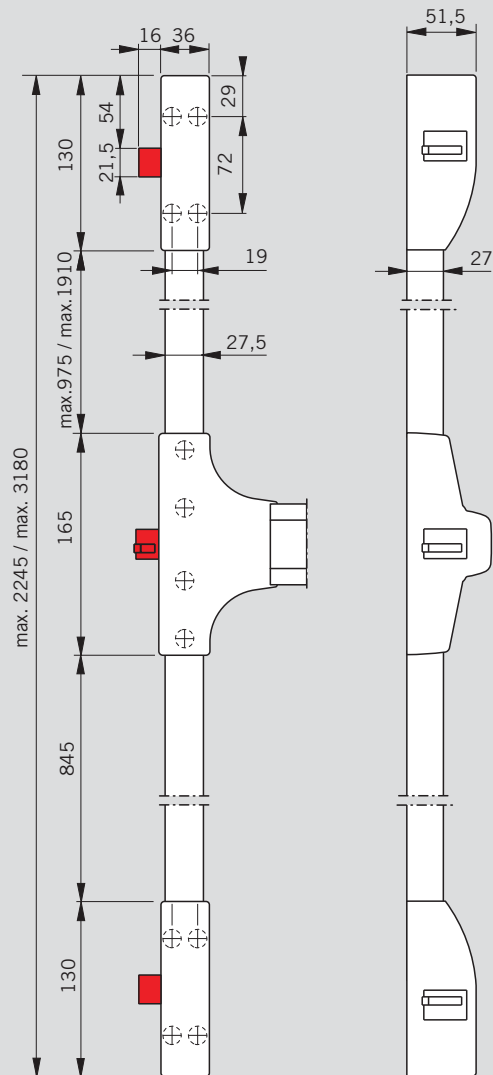
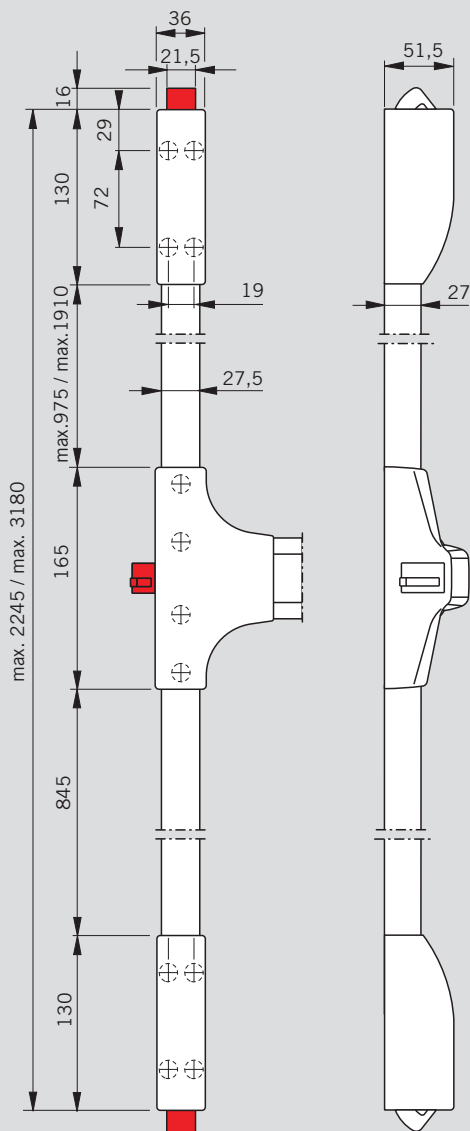

Applications and fixing details

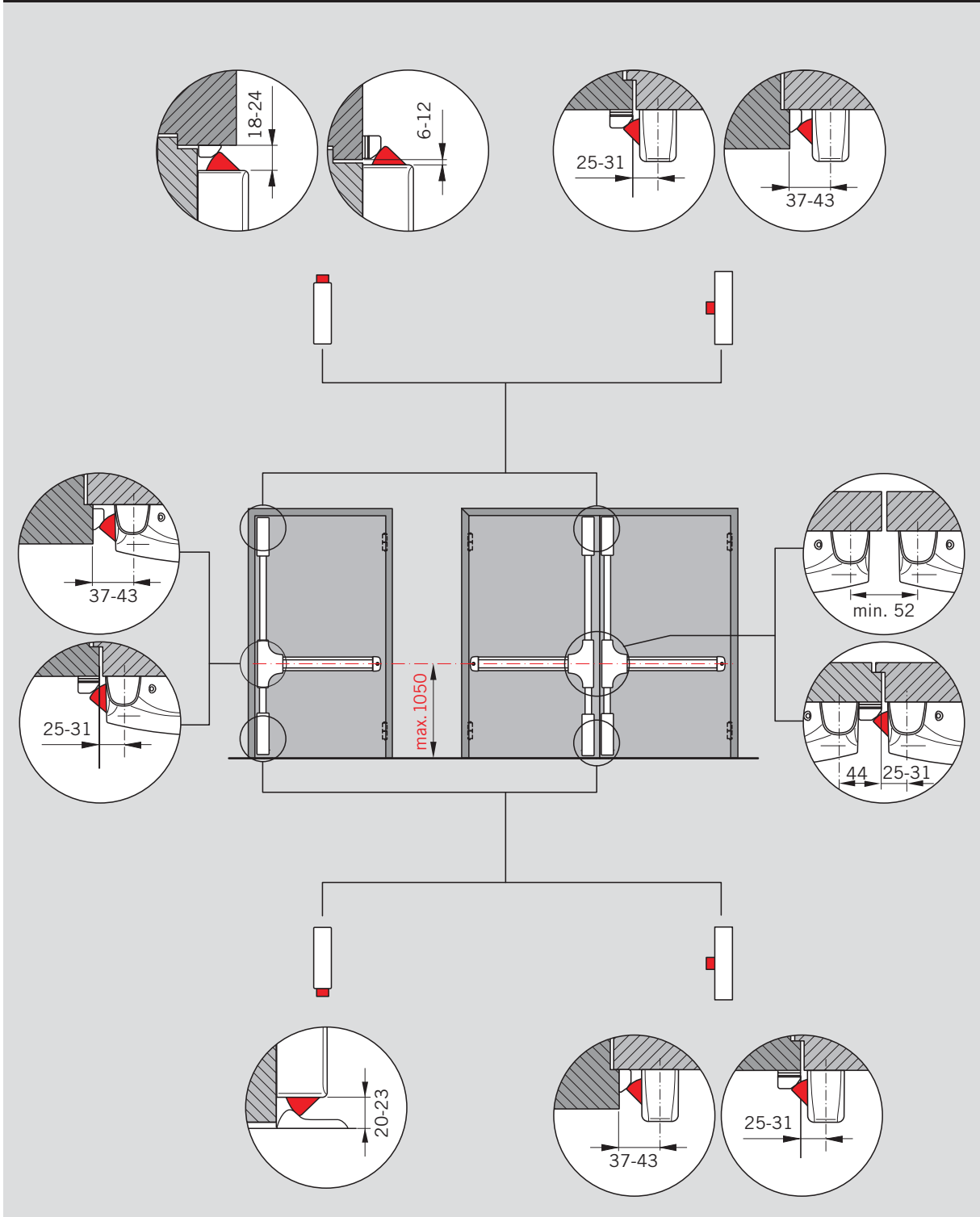

Note:

It may be the case that the panic fitting cannot be installed on extreme door situations according to standard measurements (door width X smaller than 1000

mm in connection with the distance of the hinge Y bigger than 90 mm). On request DORMA will gladly give you installation suggestions.

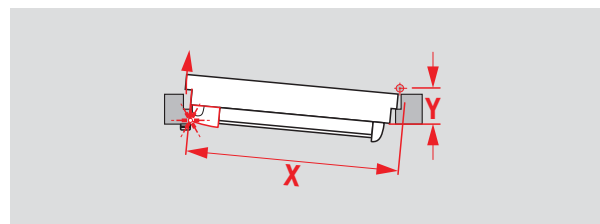

Components on single-leaf doors

Standard doors	Modular 3102 / 03	●	●	●	●	●
	Standard 3101	○				
	3203 / 04		●	●	●	●
	3201 3205 		●	●	●	●
Fire and smoke check doors F	Modular 3104 / 05	●	●	●	●	●
	3203 / 04		●	●	●	●
	3202		●	●	●	●

F Approval certification

The DORMA Panic Hardware Series PHB 3000 products marked with the **F** symbol have been tested for use on fire and smoke check doors. Test reports and/or certificates are available on request.



The DORMA Panic Hardware Series PHB 3000 carry the **CE**-conformity mark.

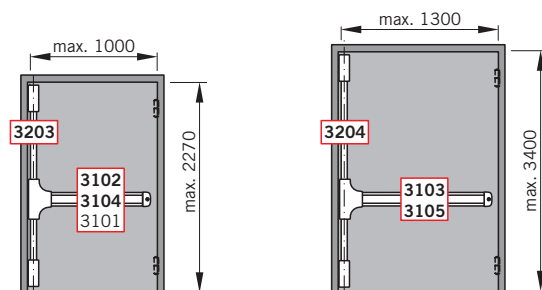

Components on double doors

over-ribated door				flush meeting stiles		
Inactive leaf	Active leaf	Inactive leaf	Active leaf	Inactive leaf	Active leaf	
●	● ○	●	●	●	●	<div style="display: flex; align-items: center;"> <div style="border: 1px solid red; padding: 2px; margin-right: 5px;">3102 / 03</div> <div style="margin-left: 5px;">Modular</div> </div> <div style="display: flex; align-items: center; margin-top: 5px;"> <div style="border: 1px solid red; padding: 2px; margin-right: 5px;">3101</div> <div style="margin-left: 5px;">Standard</div> </div>
●		●	●	●	●	<div style="display: flex; align-items: center;"> <div style="border: 1px solid red; padding: 2px; margin-right: 5px;">3203 / 04</div> </div>
●		●	●	●	●	<div style="display: flex; flex-direction: column; gap: 10px;"> <div style="display: flex; align-items: center;"> <div style="margin-right: 10px;">3201</div> </div> <div style="display: flex; align-items: center;"> <div style="margin-right: 10px;">3205</div> </div> </div>
●	●	●	●	●	●	<div style="display: flex; align-items: center;"> <div style="border: 1px solid red; padding: 2px; margin-right: 5px;">3104 / 05</div> <div style="margin-left: 5px;">Modular</div> </div>
●		●	●	●	●	<div style="display: flex; align-items: center;"> <div style="border: 1px solid red; padding: 2px; margin-right: 5px;">3203 / 04</div> </div>
●		●	●	●	●	<div style="display: flex; align-items: center;"> <div style="margin-right: 10px;">3202</div> </div>

○ = option

External trims see page 22/23

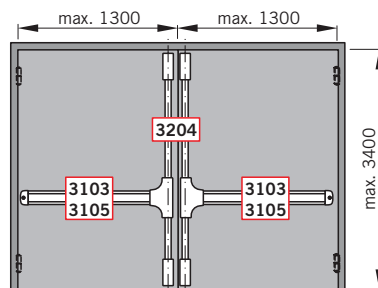
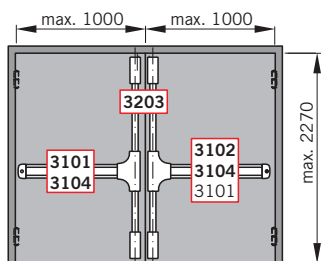

Note:

According to EN 1125 the effective length of the operating bar has to be at least 60 % of the door width. Doors higher than 2500 mm lie outside the scope of EN 1125.

Specification text

PHB Series 3000

Panic door bolt tested in accordance with EN 1125, for door widths up to 1300 mm, door heights up to 2265 (in accordance with EN 1125) or 3200 mm, non-handed. Can be unlocked electrically via electric strike. All products of the Panic Hardware series PHB 3000 carry the **CE** mark.

PHB 3101

Single-point locking, standard, for standard doors with a door width up to 1000 mm, with security anti-thrust latch and dogging device.

Die-cast zinc latch, steel latch keep with spacer plates.

- silver colour
- black/red

Order No. 35014 .. 

..31010001
..31010002  PHB 3101

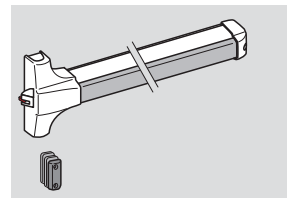
**PHB 3102**

Single-point locking, modular, for standard doors with a door width up to 1000 mm, with security anti-thrust latch and dogging device.

Die-cast zinc latch, steel latch keep with spacer plates.

- silver colour
- black/red
- white

..31020001
..31020002
..31020010  PHB 3102

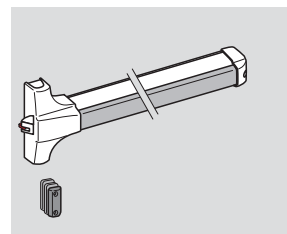
**PHB 3103**

Single-point locking, modular, for standard doors with a door width up to 1300 mm, with security anti-thrust latch and dogging device.

Die-cast zinc latch, steel latch keep with spacer plates.

- silver colour
- black/red
- white

..31030001
..31030002
..31030010  PHB 3103

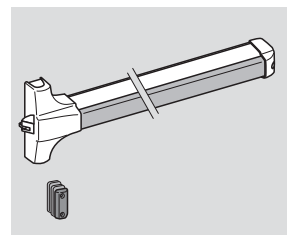
**PHB 3104 F**

Single-point locking, modular, for fire and smoke check doors with a door width up to 1000 mm, with security anti-thrust latch and dogging device.

Steel latch, steel latch keep with spacer plates.

- silver colour
- black/red
- white

..31040001
..31040002
..31040010  PHB 3104

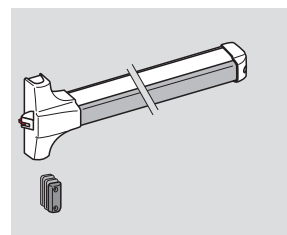
**PHB 3105 F**

Single-point locking, modular, for fire and smoke check doors with a door width up to 1300 mm, with security anti-thrust latch and dogging device.

Steel latch, steel latch keep with spacer plates.

- silver colour
- black/red
- white

..31050001
..31050002
..31050010  PHB 3105

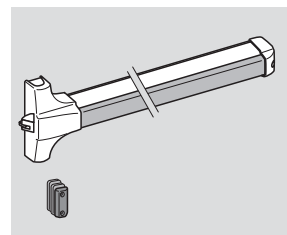

Specification text
Order No. 35014 .. 
PHB 3201

Top and bottom lock combination, with security anti-thrust latch.
Die-cast zinc latch, steel top latch keep with spacer plates,
steel bottom latch keep.

- silver colour
- black
- white

..32010001
..32010002
..32010010  PHB 3201

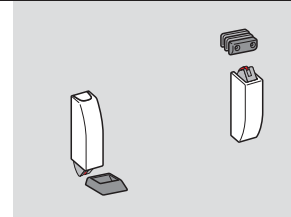
PHB 3202 F

Top and bottom lock combination, for fire and smoke
check doors, with security anti-thrust latch.
Steel latch, steel top latch keep with spacer plates,
steel bottom latch keep.

- silver colour
- black
- white

..32020001
..32020002
..32020010  PHB 3202

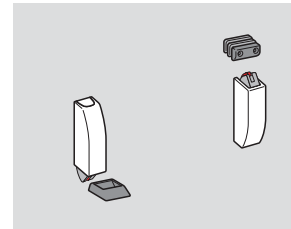
PHB 3205

Top and bottom locking combination with lateral latch,
without security anti-thrust latch. Die-cast zinc latch,
steel latch keeps with spacer plates.

- silver colour
- black
- white

..32050001
..32050002
..32050010  PHB 3205

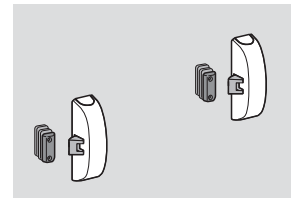
PHB 3203

Connecting rod set with cover for door heights
up to 2265 mm
Steel latch keep with spacer plates, for double doors.

- silver colour
- black
- white

..32030001
..32030002
..32030010  PHB 3203

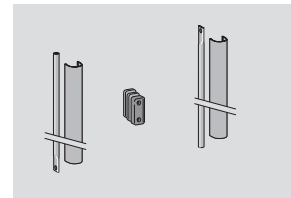
PHB 3204

Connecting rod set with cover for door heights
up to 3200 mm
Steel latch keep with spacer plates, for double doors.

- silver colour
- black
- white

..32040001
..32040002
..32040010  PHB 3204

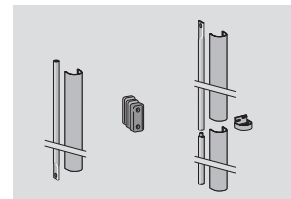

Specification text accessories PHA 2000

PH 2450 Electric door-opener

In combination with PHA/PHB for the use on Standard doors with an overlap up to 24 mm. Die-cast zinc latch counterpart. 12 V AC, 50 Hz, 15 W

- silver colour
- black
- white

..24500001
 ..24500002  PH
 ..24500010 Accessories

**PHA 2421 Adjustable keep**

For standard aluminium profile doors, single and double leaf, flush-closing or rebated (0-11 mm).

Die-cast zinc latch (in packs of 10)

- silver colour
- black
- white

..24210001
 ..24210002  PHA
 ..24210010 Accessories

**PHA 2422 Adjustable keep**

For standard PVC profile doors, single and double leaf, rebated (14-24 mm). Die-cast zinc latch (in packs of 10)

- silver colour
- black
- white

..24220001
 ..24220002  PHB
 ..24220010 Accessories

**Micro-switch**

For actuation of visual or audible signals.

Contact rating: max. 48 V DC, max. 3 A

For PHA 2101, 2102, 2201

..25200060  PHA
 Accessories

**Mounting backplate**

Steel, galvanised (in packs of 10)

for PHA 2101, 2102, 2201

for factory pre-installation to simplify field installation

..25200050  PHA
 Accessories

**Mounting backplate**

Steel, galvanised (in packs of 10)

for PHA 2202, 2203

for factory pre-installation to simplify field installation

..25200051  PHA
 Accessories



Specification text accessories PHB 3000

PH 2450 Electric door-opener

In combination with PHA/PHB for the use on Standard doors with an overlap up to 24 mm. Die-cast zinc latch counterpart.

12 V AC, 50 Hz, 15 W

- silver colour
- black
- white

..24500001
 ..24500002  PH
 ..24500010 Accessories

**Micro-switch**

For actuating visual or audible signals.

Contact rating: max. 48 V DC, max. 3 A

For PHB 3101, 3102, 3103, 3104, 3105.

..35200061  PHB
 Accessories



PH 2450 – Electric strike

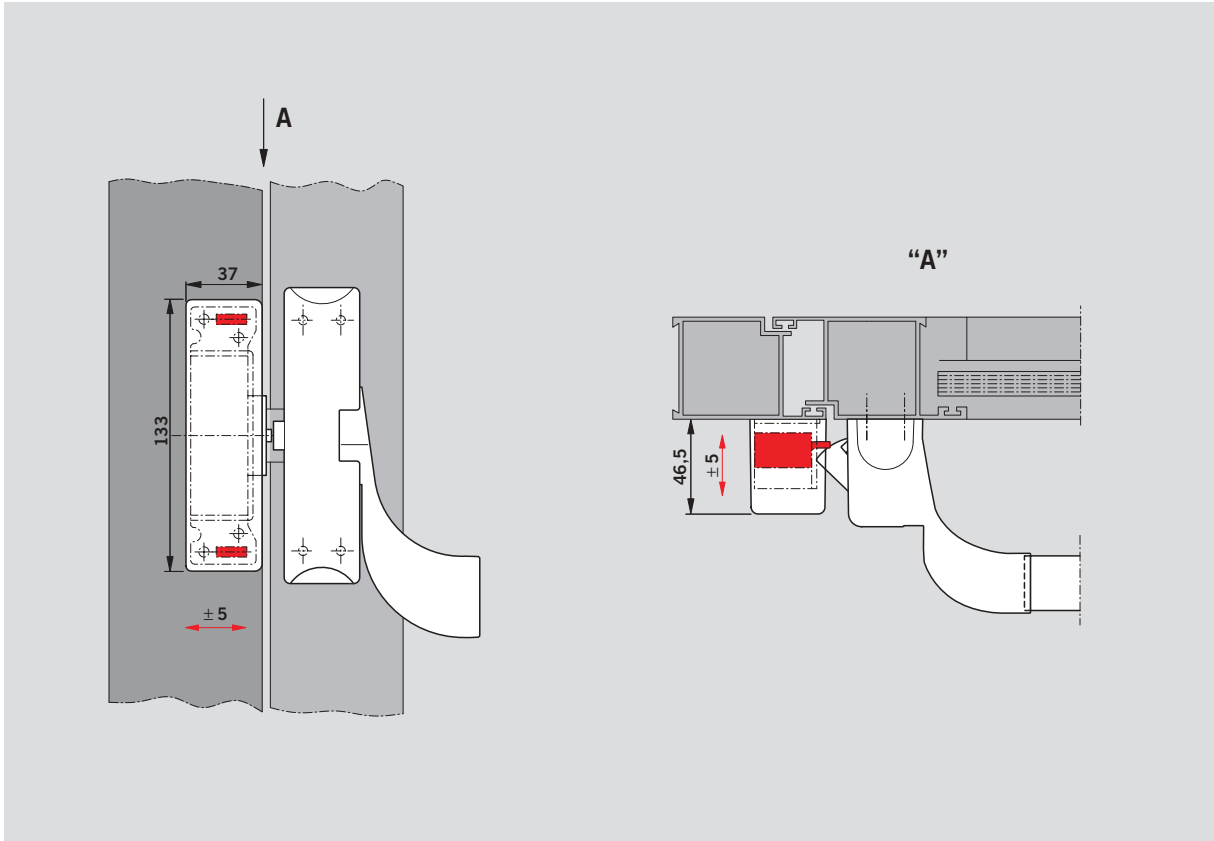

Application of the electric strike in combination with PHA 2000 on a profile door

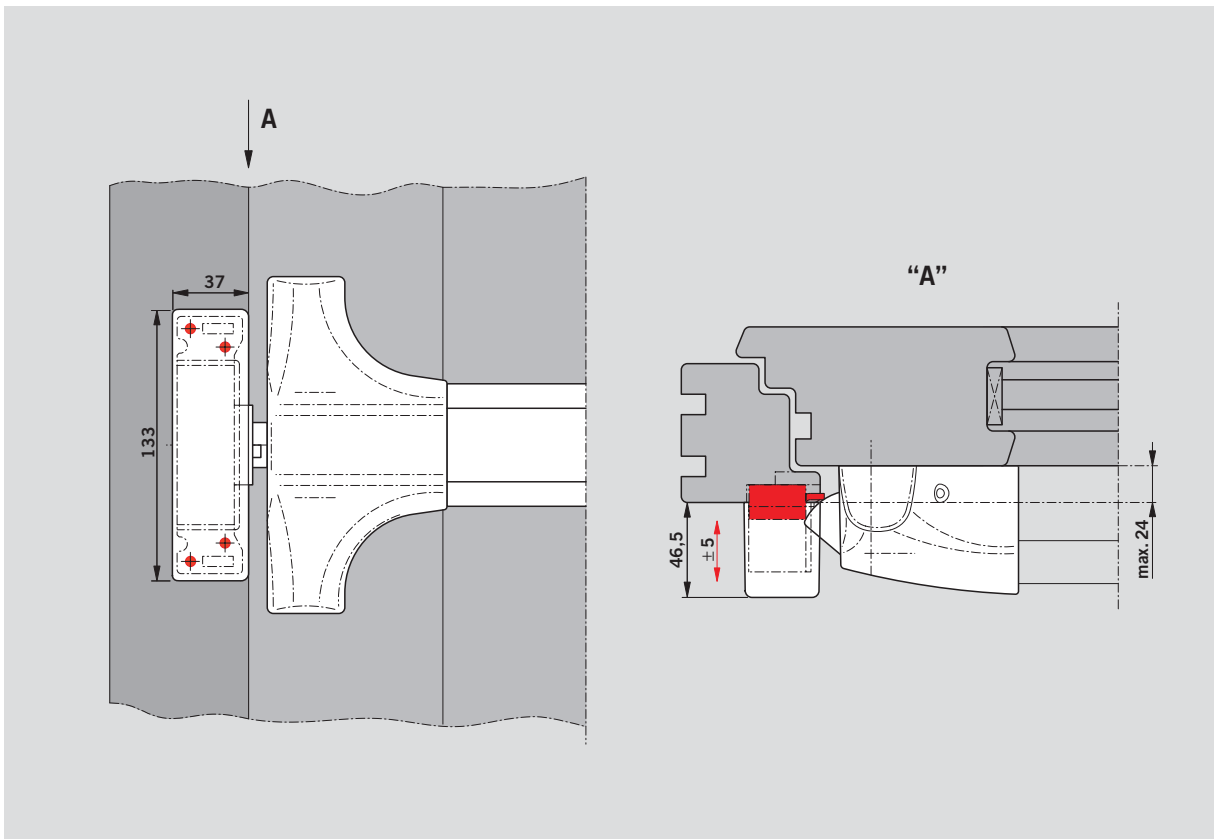

Application of the electric strike in combination with PHB 3000 on a timber door

PHA 2421 – Adjustable keep for aluminium profile doors

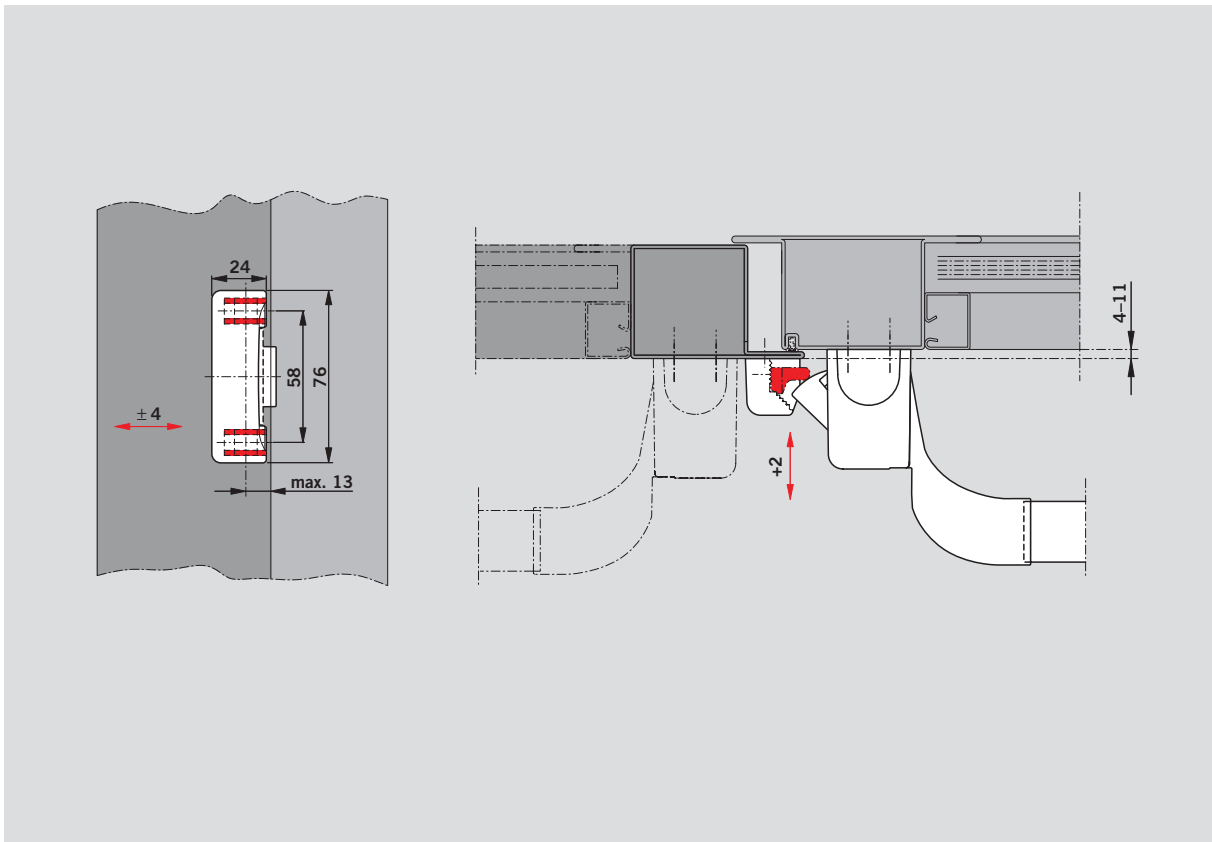

Application example PHA 2421 on a rebated door, universal use for single and double leaf doors

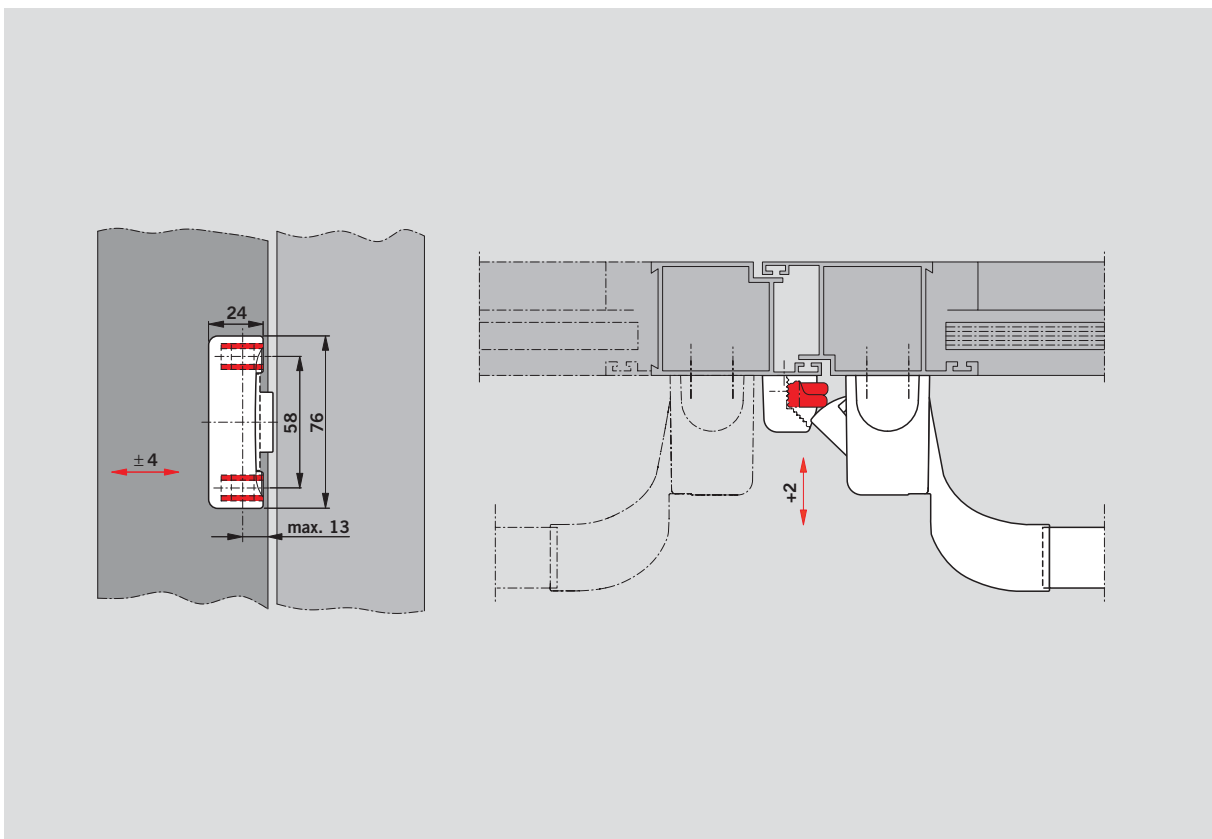

Application example PHA 2421 on a flush-closing door, universal use for single and double leaf doors

PHA 2422 – Adjustable keep for PVC profile doors

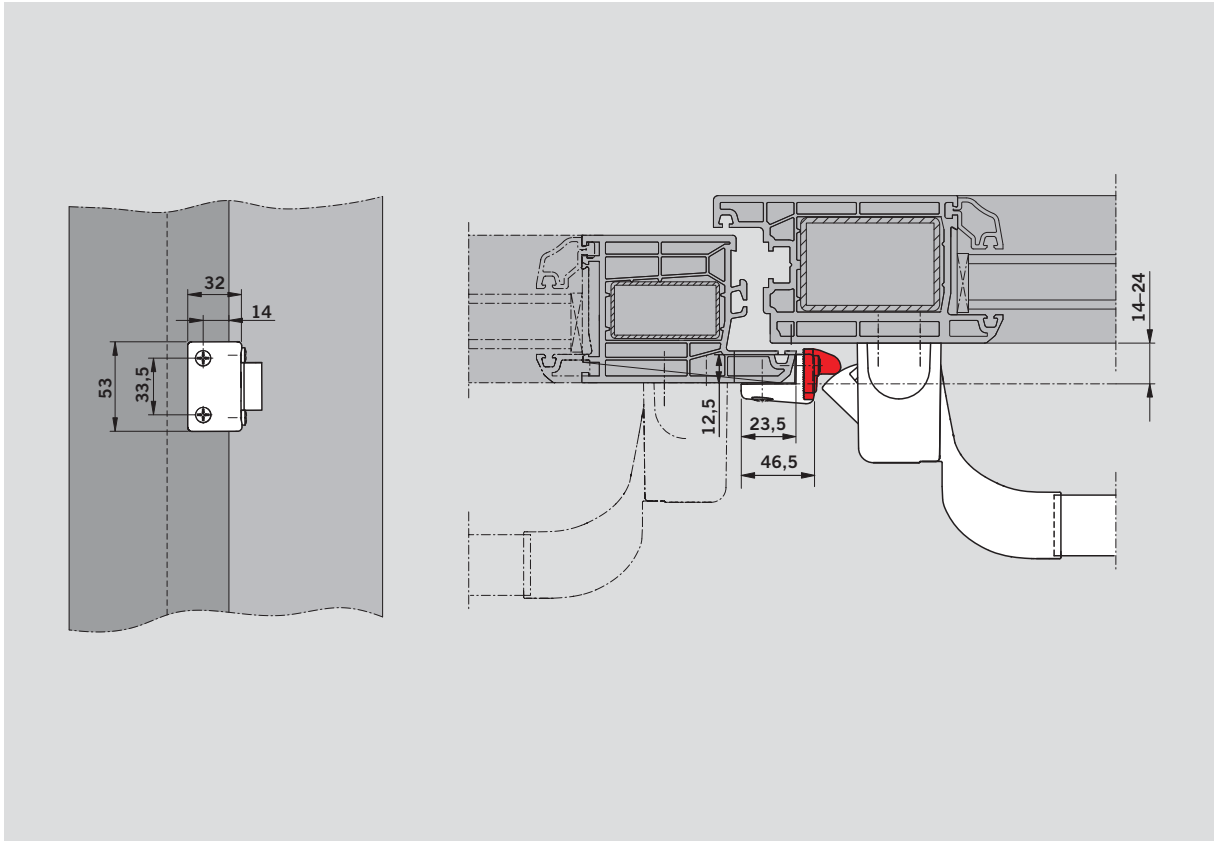

Application example PHA 2422 on a rebated door, universal use for single and double leaf doors

3901, 3903, 3905

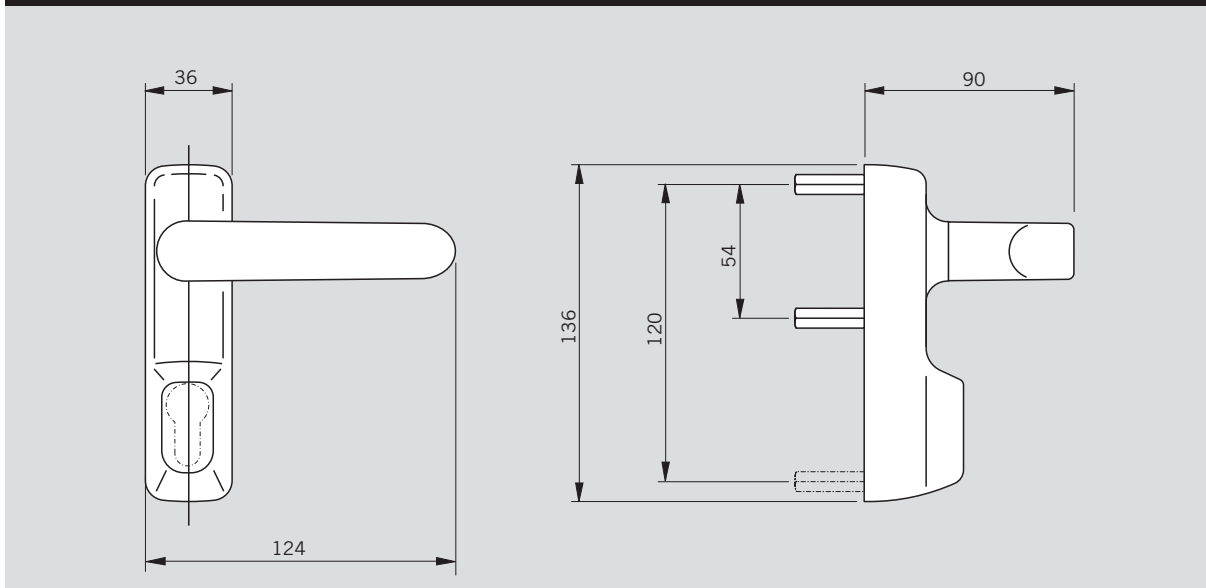

3902, 3904

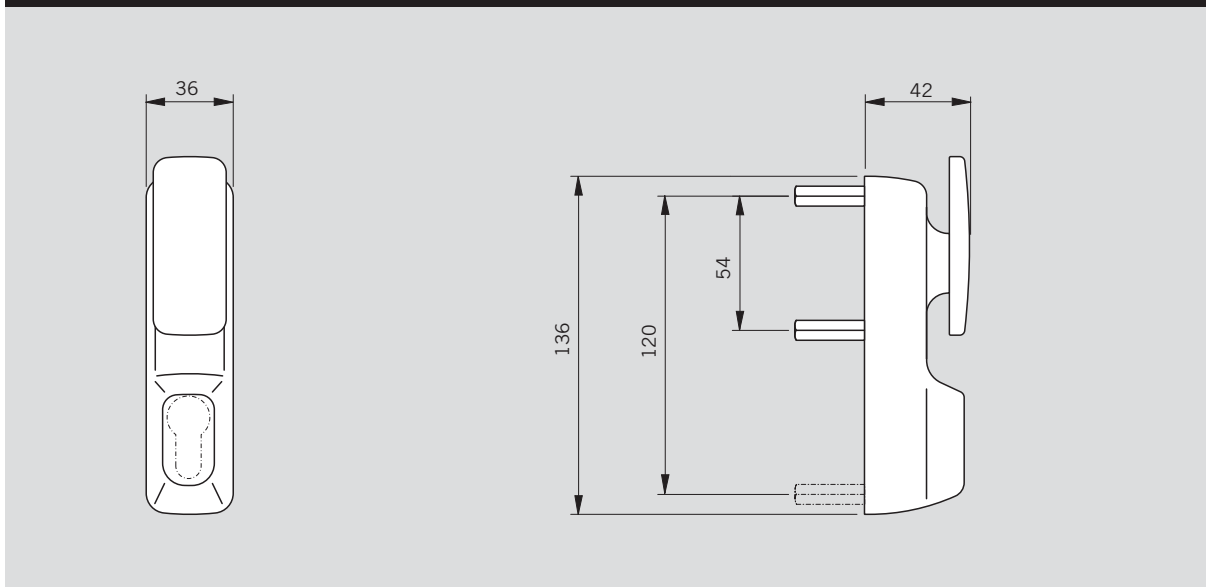

F

When DORMA PHT 3905 external fittings are used on fire and smoke check doors in conjunction with the PHA or PHB Panic Hardware series, the appropriate seal set must be used.

CE

The Panic Hardware products of the series PHT 3900 carry the **CE** mark.

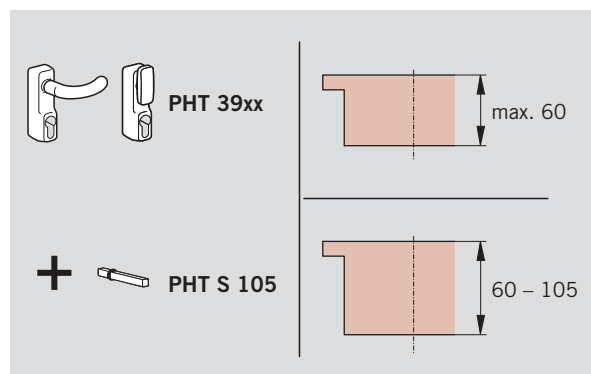

Specification text**Order no. 35014 ..** **PHT Series 3900**

External trims with lever handle or knob, usable with PHA 2000 and PHB 3000. All external trims PHT 3900 are non-handed and carry the  mark.

PHT 3901

External fitting with OGRO Design lever handle, for standard doors with a door leaf thickness up to 60 mm, prepared for Europrofile single cylinder.

With handle spindle and 2 cylinder fixing bolts.

- silver colour
- black
- white

..39010001
 ..39010002
 ..39010010  PHT 3901

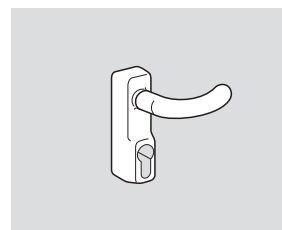
**PHT 3903**

External fitting with OGRO Design lever handle, for standard doors with a door leaf thickness up to 60 mm, non-lockable.

With handle spindle.

- silver colour
- black
- white

..39030001
 ..39030002
 ..39030010  PHT 3903

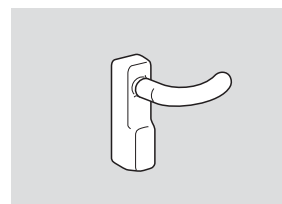
**PHT 3905 **

External fitting with OGRO Design lever handle, for fire and smoke check doors with a door leaf thickness up to 60 mm.

With integrated seal ring. Prepared for Europrofile single cylinder. With handle spindle and 2 cylinder fixing bolts.

- silver colour
- black
- white
- stainless steel design

..39050001
 ..39050002
 ..39050010
 ..39050004  PHT 3905

**PHT 3902**

External fitting with knob, for standard doors with a door leaf thickness up to 60 mm, prepared for Europrofile single cylinder.

With handle spindle and 2 cylinder fixing bolts.

- silver colour
- black
- white
- stainless steel design

..39020001
 ..39020002
 ..39020010
 ..39020004  PHT 3902

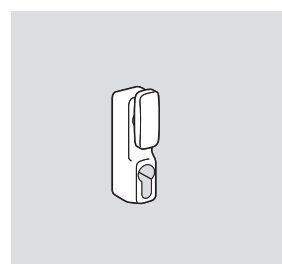
**PHT S 105****Extended spindle for PHT 3900**

8 mm square, incl. fixings screws for door thickness from 60-105 mm.

..39200050  PHT
 Accessories

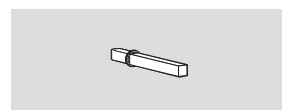

 **Seal set** for external fitting and **PHA** panic door locks on fire and smoke check doors.

..39200060  PHT
 Accessories

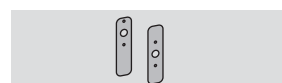

 **Seal set** for external fitting and **PHB** panic door locks on fire and smoke check doors.

..39200061  PHT
 Accessories



www.dorma.com

Division Door Control worldwide

Central Europe

DORMA GmbH + Co. KG
Breckerfelder Str. 42-48
D-58256 Ennepetal
Tel. +49 23 33/793-0
Fax +49 23 33/793-495

Scanbalt

DORMA Danmark A/S
Sindalvej 6 - 8
DK-2610 Rødovre
Tel. +45 44/54 30 00
Fax +45 44/94 95 04

Australia

DORMA Door Controls Pty. Ltd.
52 Abbott Road
Hallam/Victoria 3803
Australia
Tel. +61 3/97 96 35 55
Fax +61 3/97 96 39 55

South Africa

DORMA Door Controls (Pty.) Ltd.
Kings Court, 4A Mineral Crescent
ZA-2000 Crown/Gauteng
Johannesburg
Tel. +27 11/8 30 02 80
Fax +27 11/8 30 02 91

Emerging Markets

DORMA GmbH + Co. KG
Breckerfelder Str. 42-48
D-58256 Ennepetal
Tel. +49 23 33/793-0
Fax +49 23 33/793-495

South America

DORMA Sistemas de Controles
para Portas Ltda.
Av. Piracema, 1400
Centro Empresarial Tambore
CEP 06400 Barueri/
São Paulo, Brasil
Tel. +55 11/41 91 32 44
Fax +55 11/41 91 21 93

Far East

DORMA Door Controls Pte. Ltd.
No. 2 Jalan Terusan,
Jurong
Singapore 619285
Tel. +65 62 68/76 33
Fax +65 62 65/79 14

South-East Europe

DORMA AUSTRIA GmbH
Pebering Strass 22
A-5301 Eugendorf
Tel. +43 62 25/2 84 88
Fax +43 62 25/2 84 91

France

DORMA France S.A.S.
Europarc
42, rue Eugène Dupuis
F-94046 Créteil
Tel. +33 1/41 94 24 00
Fax +33 1/41 94 24 01

South Europe

DORMA Italiana S.r.l.
Via. A. Canova 44/46
I-20035 Lissone (MI)
Tel. +39 039/24 40 31
Fax +39 039/24 40 33 10

Gulf

DORMA Gulf Door Controls FZE
Jebel Ali Free Zone,
Roundabout 8,
Unit VC 02
Dubai, United Arab Emirates
Tel. +971 48/83 90 14
Fax +971 48/83 90 15

DORMA Ibérica, S.A.
Camino San Martin de la Vega, 4
E-28500 Arganda del Rey
(Madrid)
Tel. +34 91/8 75 78 50
Fax +34 91/8 75 78 81

UK/Ireland

DORMA UK Ltd.
Door Controls Division
Wilbury Way
GB-Hitchin
Hertfordshire SG4 0AB
Tel. +44 14 62/47 76 00
Fax +44 14 62/47 76 01

North America

DORMA Architectural Hardware
DORMA Drive, Drawer AC
Reamstown, PA 17567
Tel. +1-800-523-8483
Fax +1-800-274-9724



Door Control



Automatic



Glass Fittings and Accessories



Security/ Time and Access (STA)



Movable Walls

