



Door Closer

# DORMA TS 73 V

**New**

- ideal dimensions
- optimised features

## Easy to fit, economical and with adjustable closing force

Simple, easy installation, and guaranteed quality.

### Tested to EN 1154

Specially designed for internal doors, including fire doors, the DORMA TS 73 V is a universal solution for doors of differing designs and styles.

The flat and compact format of the TS 73 V means that there are practically no problems with installation; and tried and trusted quality is your assurance of reliability. Certified to ISO 9001

### Why everyone gains – point by point

#### For the trade

- One model for all applications.
- Really practical solutions for special installation situations, thanks to the wide range of accessories.

#### For the installer

- Quick and simple to fit. Closing force, closing speed, and latching action all set with just a few manual adjustments.
- Only one design for DIN-L and DIN-R doors, and for standard and framefixing.

#### For the designers

- Compact format in time-less design.
- Attractively-priced solution with optimum reliability.
- Wide range of applications.
- Anti-corrosive design for moist and damp areas.

#### For the user

- Optimum wall and door protection thanks to "thinking" backcheck.
- Constant closing speed virtually unaffected by temperature fluctuations, with adjustable latch action.
- Smooth door action thanks to high mechanical efficiency.



The TS 73 V complies with the requirements and/or recommendations of the following: CERTIFIRE approved for fire doors ITT 120; MM/IMM 240; Ref. CF 117

Data and features		TS 73 V
Closing force adjustable	Size	EN 2-4
Standard doors <sup>1)</sup>	≤ 1100 mm	●
External doors, opening outwards <sup>1)</sup>		–
Fire and smoke check doors <sup>1)</sup>	≤ 1100 mm	●
Non-handed		●
Arm	Standard	●
	Flat form	●
	Slide channel	–
Closing force adjustable by means of setting screw		●
Closing speed adjustable at 2 separate valves	180° - 15°	●
	15° - 0°	●
Backcheck	self-regulating	●
	adjustable at valve	●
Adjustable latching action	by arm	●
Delayed action		–
Hold-open		○
Weight in kg		1.3
Dimensions in mm	Length	225
	Depth	40
	Height	60
Door closer tested to EN 1154		●
CE mark for construction products		●

● Yes – No ○ Option

<sup>1)</sup> For high and heavy doors, external doors, and for doors required to close against high wind pressure, we recommend DORMA TS 83.

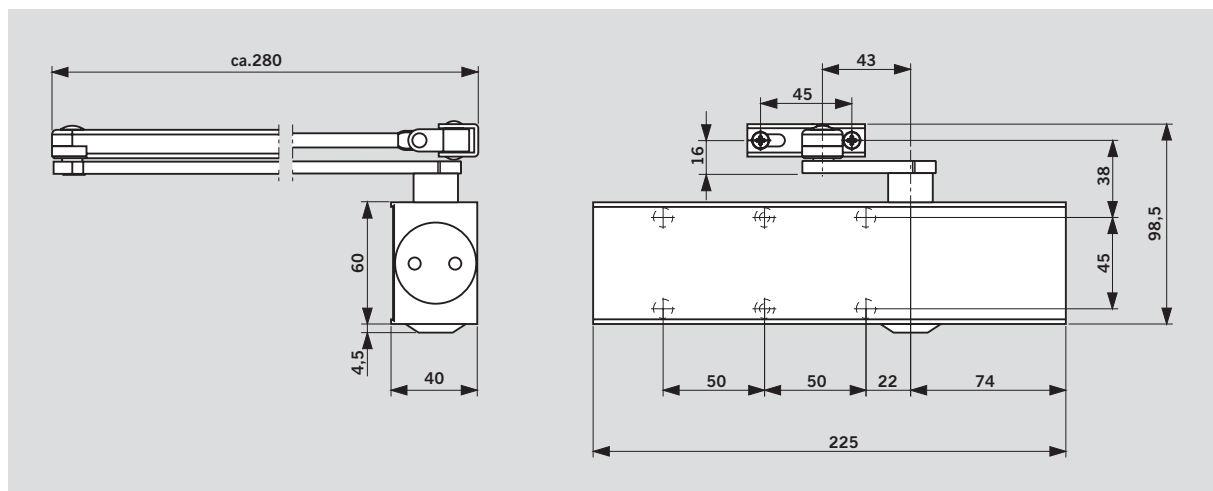

**Features and optional functions**

## With “thinking” backcheck (BC/ÖD)

Thanks to an innovative design concept, the resistance developed by this backcheck system as the door is opened beyond approx. 70° is directly proportional to door acceleration.

It is almost imperceptible when the door is opened slowly. However, if the door is opened hastily, the backcheck responds in equal measure.

And if the door should be flung open at speed – whether deliberately, thoughtlessly, accidentally or as a result of a gust of wind – the backcheck reacts at full strength, protecting the wall and door from damage.

**If no backcheck function is required, the system can simply be switched off.**

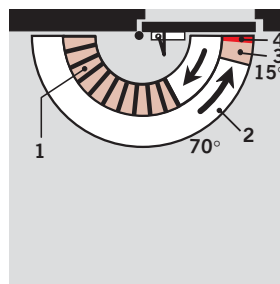

- 1 Self-regulating backcheck
- 2 Infinitely variable closing speed in the range 180° – 15°
- 3 Infinitely variable closing speed in the range 15° – 0°
- 4 Adjustable latch range (by arm)

## With hold-open arm

Combining the TS 73 V with a hold-open arm enables the door to be held open at an appropriate angle (up to approx. 150°).

Hold-open arm with switch: The hold-open function can be switched on and off by the user by simply pressing a switch.

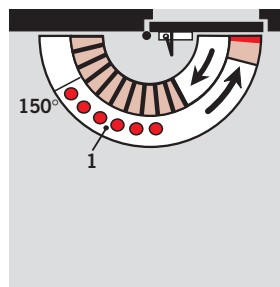

- 1 Hold-open range

**Hold-open arms are not permitted on fire doors**

**Door leaf fixing, pull side** (example shows LH (ISO 6) door; RH (ISO 5) doors mirrored arrangement)

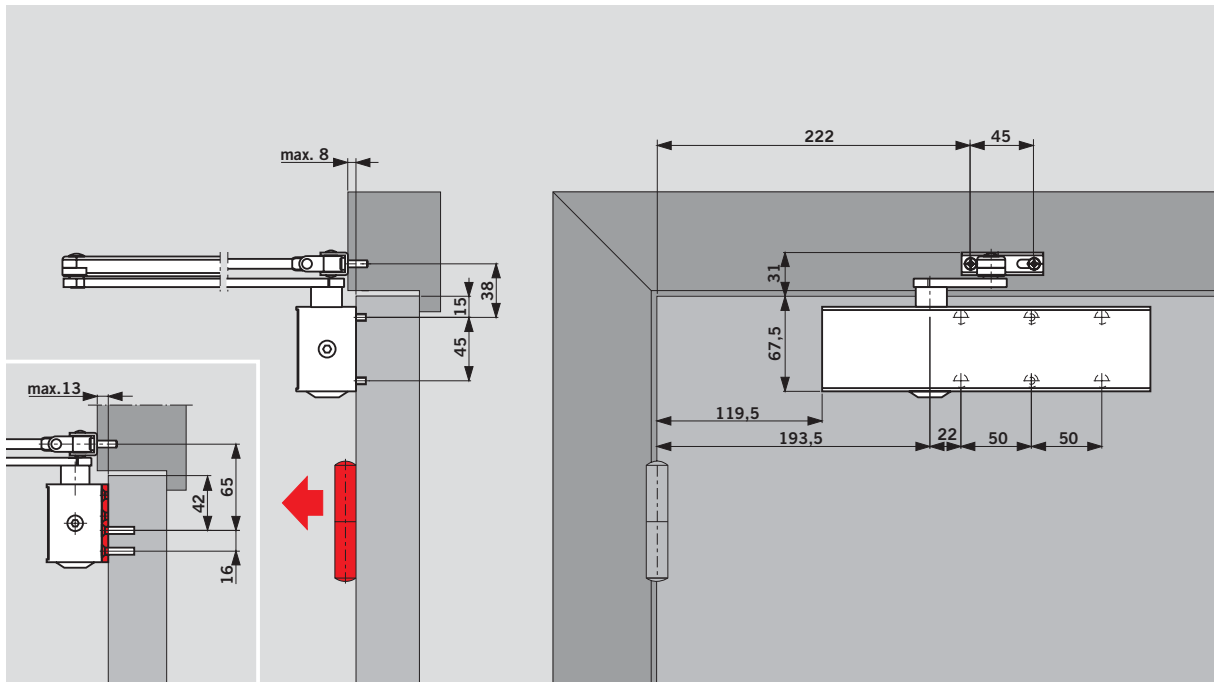

**Door leaf fixing with hold-open arm** (example shows LH (ISO 6) door; RH (ISO 5) doors mirrored arrangement)

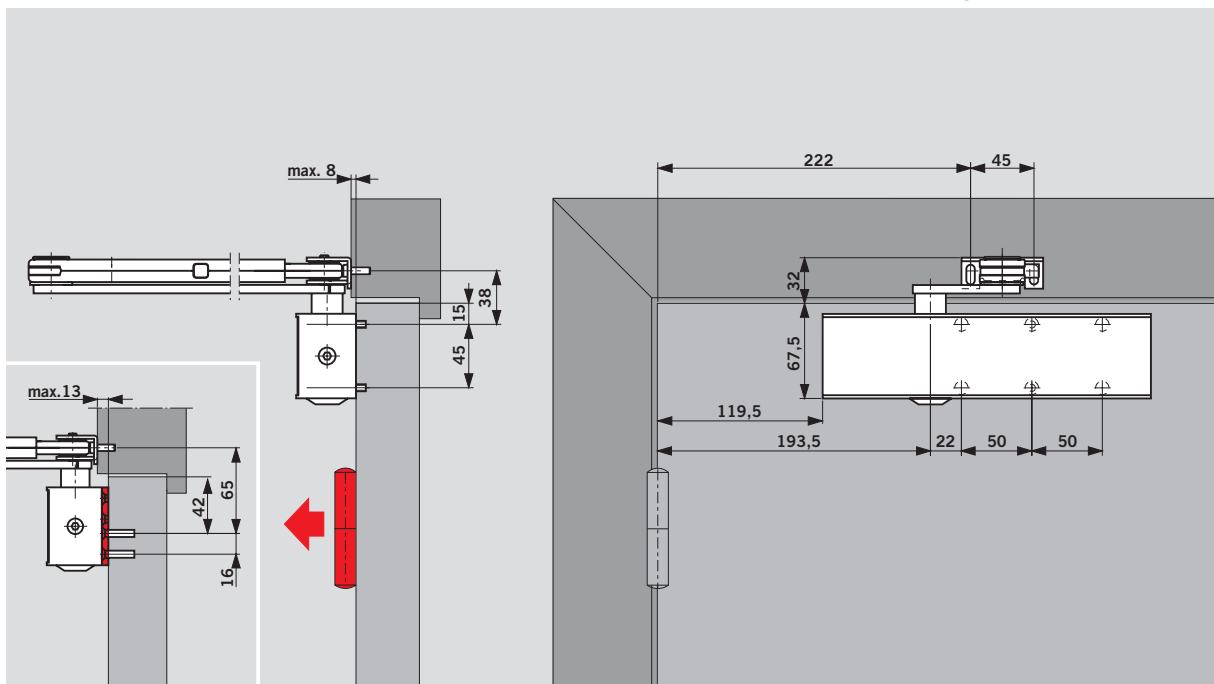

## Transom fixing, push side (example shows LH (ISO 6) door; RH (ISO 5) doors mirrored arrangement)

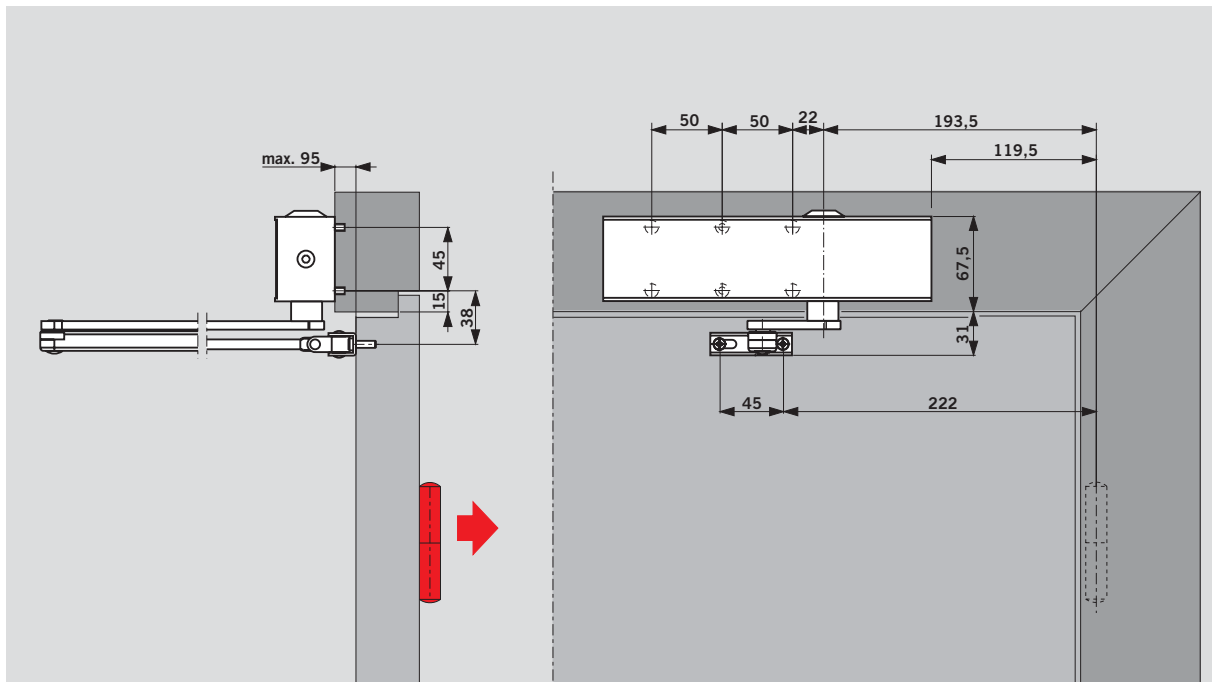

Door closers may only be fitted on the frame of fire doors if proved suitable for the individual door by the issue of an approval certificate from a recognised testing institution.

**Mounting plate**

For fitting the door closer to fire doors and to doors where direct fitting is not possible. Hole group according to EN 1154, supplement 1.

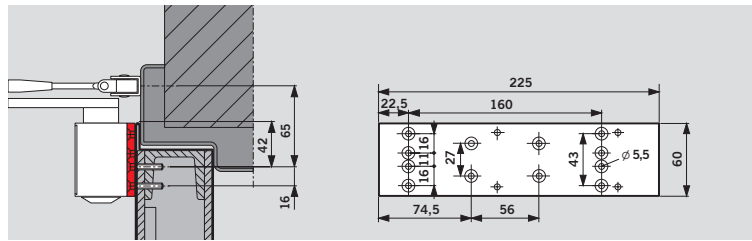

**Hinge plate**

For securing the arm to particularly narrow door frames.

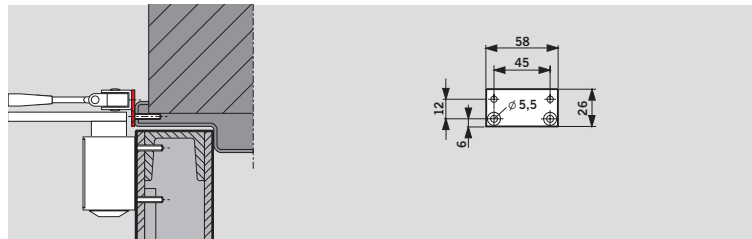

**Glass door saddle plate**

For securing the door closer to all-glass doors; no need for any glass preparation (to suit 8 – 10 mm door thickness).

**Not approved for fire doors.**

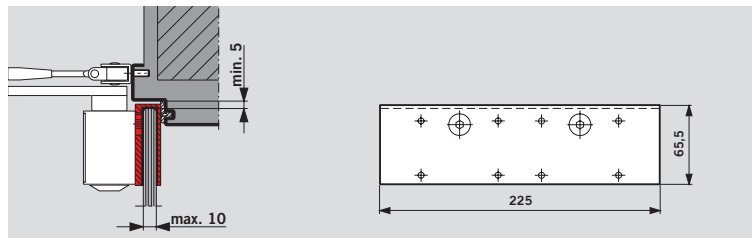

**Angle bracket**

For overhead fitting on the push side, for deep-set door lintels.

**On fire doors, proof of suitability required in relation to the individual door concerned.**

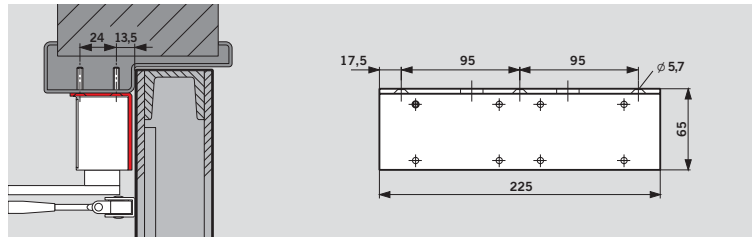

**Drop plate**

For use where the closer cannot be fitted directly to the door.

**On fire doors, proof of suitability required in relation to the individual door concerned.**

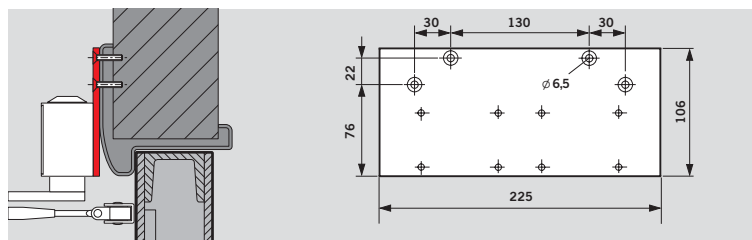

**Parallel arm bracket**

For parallel arm installation (see installation instructions for fitting dimensions).



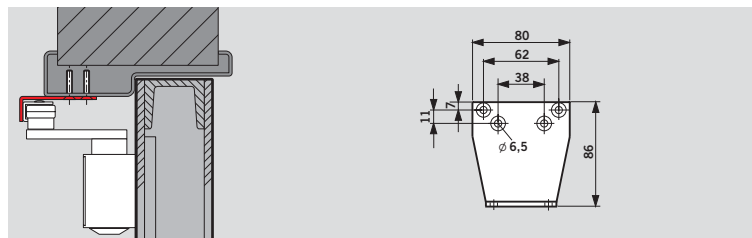





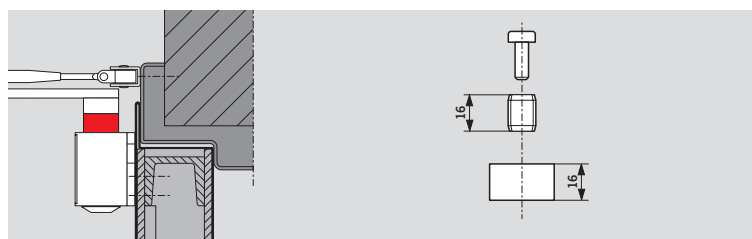

**On fire doors, proof of suitability required in relation to the individual door concerned.**

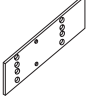

**Spindle extension**

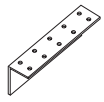
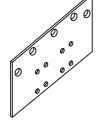
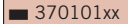
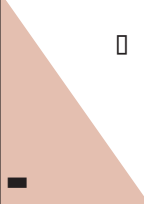
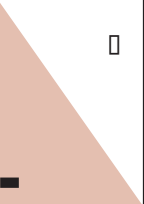
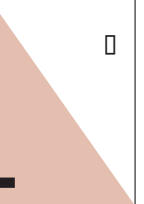
For increasing the distance between the closer and the arm assembly in the case of doors with a high overlap; 16 mm high.

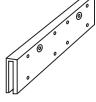

Range of equipment				Accessories			
Closer body TS 73 V  	Standard arm   □ 220023xx	Flatform arm   □ 830001xx	Hold-open arm with on/off switch   □ 220030xx	Mounting plate   370001xx	Hinge plate   830014xx	Angle bracket   370003xx	Drop plate   370002xx
Size EN 2-4   370101xx	 □	 □	 □	Parallel arm bracket   280066xx	Glass door saddle plate   370004xx	Spindle extension 16 mm   83003705	

Order number:

■ = Body only

□ = Arm only

Colour xx

silver 01

white (RAL 9016) 11

special 09

**Specification text**

DORMA TS 73 V rack and pinion door closer; with adjustable power size EN 2 – 4, according to EN 1154, carries the CE mark, integral self-regulating backcheck; closing speed adjustable in two independent ranges and adjustable latch action. Non-handed.

**Model**

- with standard arm
- with flatform arm
- with hold-open arm with on/off switch

**Accessories** \_\_\_\_\_

**Colour**

- Silver
- White (sim. RAL 9016)
- Special \_\_\_\_\_ (sim. RAL \_\_\_\_\_)

**Make:** DORMA TS 73 V

TS73V

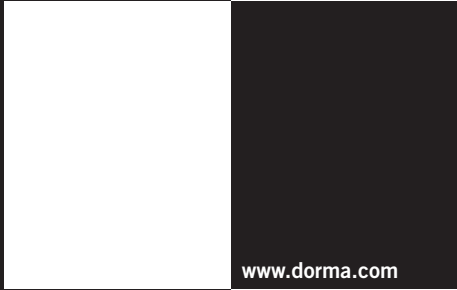

[www.dorma.com](http://www.dorma.com)

## Door Control Division worldwide

### Central Europe

DORMA GmbH + Co. KG  
Breckerfelder Str. 42-48  
D-58256 Ennepetal  
Tel. +49 23 33/7 93-0  
Fax +49 23 33/7 93-495

### Australia

DORMA Door Controls Pty. Ltd.  
52 Abbott Road  
Hallam/Victoria 3803  
Australia  
Tel. +61 3/97 96 35 55  
Fax +61 3/97 96 39 55

### China

DORMA Door Controls (Suzhou)  
Co. Ltd.  
No. 9, Hong Feng Road  
Suzhou Singapore Industrial Park  
Suzhou, 215021  
P. R. of China  
Tel. +86 512/67612481  
Fax +86 512/67614582

DORMA Door Controls Pte. Ltd.  
Room 701, Technology Plaza  
651 King's Road  
North Point  
Hong Kong  
Tel. +825/250 34632  
Fax +825/288 75370

### Emerging Markets

DORMA GmbH + Co. KG  
Breckerfelder Str. 42-48  
D-58256 Ennepetal  
Tel. +49 23 33/7 93-0  
Fax +49 23 33/7 93-495

DORMA Door Controls (Pty.) Ltd.  
Kings Court, 4A Mineral Crescent  
ZA-2000 Crown/Gauteng  
South Africa  
Tel. +27 11/8 30 02 80  
Fax +27 11/8 30 02 91

### Far East

DORMA Far East Pte. Ltd.  
No. 31 Gul Lane,  
Singapore 629425  
Tel. +65 62 68/76 33  
Fax +65 62 65/79 14

### France

DORMA France S.A.S.  
Europarc  
42, rue Eugène Dupuis  
F-94046 Créteil  
Tel. +33 1/41 94 24 00  
Fax +33 1/41 94 24 01

### Gulf

DORMA Gulf Door Controls FZE  
Jebel Ali Free Zone,  
Roundabout 8,  
Unit VC 02  
Dubai, United Arab Emirates  
Tel. +971 48/83 90 14  
Fax +971 48/83 90 15

### North America

DORMA Architectural Hardware  
DORMA Drive, Drawer AC  
Reamstown, PA 17567  
Tel. +1-800-523-8483  
Fax +1-800-274-9724

### Scanbalt

DORMA Danmark A/S  
Sindalvej 6 - 8  
DK-2610 Rødovre  
Tel. +45 44/54 30 00  
Fax +45 44/54 30 01

### South America

DORMA Sistemas de Controles  
para Portas Ltda.  
Av. Piracema, 1400  
Centro Empresarial Tambore  
CEP 06400 Barueri/  
São Paulo, Brasil  
Tel. +55 11/41 91 32 44  
Fax +55 11/41 91 21 93

### South-East Europe

DORMA AUSTRIA GmbH  
Pebering Strass 22  
A-5301 Eugendorf  
Tel. +43 62 25/2 84 88  
Fax +43 62 25/2 84 91

### South Europe

DORMA Italiana S.r.l.  
Via. A. Canova 44/46  
I-20035 Lissone (MI)  
Tel. +39 039/24 40 31  
Fax +39 039/24 40 33 10  
DORMA Ibérica, S.A.  
Camino San Martin de la Vega, 4  
E-28500 Arganda del Rey  
(Madrid)  
Tel. +34 91/8 75 78 50  
Fax +34 91/8 75 78 81

### UK/Ireland

DORMA UK Ltd.  
Door Controls Division  
Wilbury Way  
Hitchin  
Hertfordshire SG4 0AB  
Tel. +44 14 62/47 76 00  
Fax +44 14 62/47 76 01



Door Control

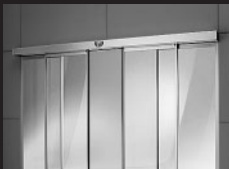

Automatic



Glass Fittings  
and Accessories



Security/Time  
and Access (STA)



Movable Walls

